



Experts in  
fibre cement



## Technical Data

# Slates

ARDONIT & MONTANA

United Kingdom

# Table of contents

<b>MATERIALDATA</b>		<b>4</b>
<b>1</b>	<b>INTRODUCTION</b>	<b>4</b>
1.1	SCOPE	4
1.2	COMPOSITION AND MANUFACTURE	4
1.3	PRODUCT RANGE	5
1.3.1	SLATES	5
1.3.2	ACCESSORIES	6
1.3.3	EXTRA ACCESSORIES AND FIXINGS	8
1.4	PRODUCT QUALITY	9
1.4.1	MECHANICAL AND PHYSICAL CHARACTERISTICS	9
1.4.2	QUALITY CERTIFICATES	9
1.4.3	WARRANTY	9
<b>2</b>	<b>DESIGN CRITERIA</b>	<b>10</b>
2.1	RAIN AND SNOW RESISTANCE	10
2.2	SAFETY	12
2.3	TRANSPORT AND STORAGE	12
2.4	CUTTING AND DRILLING SLATES	12
2.4.1	GENERAL	12
2.4.2	CUTTING	12
2.4.3	DRILLING	12
2.5	FIXINGS	13
2.5.1	GENERAL	13
2.5.2	FIXING METHODS	13
2.5.3	COMPLEMENTARY PRODUCTS	14
2.6	COVERING	15
2.6.1	CAPILLARITY	15
2.6.2	WEATHER CONDITIONS	15
2.6.3	LENGTH OF THE ROOF SURFACE	15
2.6.4	ROOF PITCH	16
2.7	MAINTENANCE	17
2.7.1	CAUSE OF THE POLLUTION	17
2.7.2	METHOD	17
2.7.3	MECHANICAL CLEANING	17
2.7.4	CHEMICAL CLEANING	17
<b>3</b>	<b>SLATING SYSTEMS</b>	<b>18</b>
3.1	VERTICAL DOUBLE-LAP (ROOF - FACADE)	18
3.1.1	PRINCIPLE	18
3.1.2	MINIMUM HEAD-LAP – ROOF PITCH	19
3.1.3	FIXING	19
3.1.4	NUMBER AND DIMENSIONS	19
3.1.5	DIMENSIONS OF THE BOTTOM SLATES AND THE POSITION OF THE BOTTOM ROW BATTENS	19
3.2	HORIZONTAL DOUBLE-LAP (ROOF - FACADE)	20
3.2.1	PRINCIPLE	20
3.2.2	MINIMUM HEAD-LAP – ROOF PITCH	20
3.2.3	FIXING	20
3.2.4	DIMENSIONS OF THE BOTTOM SLATES AND THE POSITION OF THE BOTTOM ROW BATTENS	20
3.2.5	NUMBER AND DIMENSIONS	21
3.3	OTHER SLATING SYSTEMS	21
<b>4</b>	<b>CONSTRUCTION</b>	<b>22</b>
4.1	ROOFING COMPONENTS	22
4.1.1	SUPPORTING FRAMEWORK	22
4.1.2	ROOFING UNDERLAY	22
4.1.3	COUNTER-BATTENS	22
4.1.4	BATTENS	23
4.1.5	INSULATION, AIR AND VAPOUR TIGHTNESS	23
4.1.6	VENTILATION	24
4.2	SLATE FIXING METHOD	25

4.3	CONSTRUCTION DETAILS	27
4.3.1	EAVES	28
4.3.2	VERGES	30
4.3.3	RIDGES	32
4.3.4	HIPS	34
4.3.5	VALLEYS	36
4.3.6	ABUTMENTS	37
5	REFERENCES	39

*This technical information is meant to inform you about the SVK slates and how to apply them. Information about the bearing construction, fixing materials and other products / accessories is only informative and not binding. Always ask information from the manufacturer or the supplier of these products and follow their advice. SVK slates must be applied in compliance with the national and/or local building regulations and guidelines. If these do not correspond with the SVK-guidelines, SVK must be contacted before construction starts.*

*Our product guarantee is only valid if construction is carried out conform our most recent technical data, which can be acquired by simple demand. You can also find them on our website [www.svk.be](http://www.svk.be).*

## MATERIAL DATA

### 1 INTRODUCTION

SVK has over 100 years of manufacturing, supply and technical expertise. As one of the biggest manufacturers of building materials in Europe, SVK offers one of the most comprehensive portfolios of fibre-cement products. SVK has a presence of over 30 years in the U.K., supplying roofing materials to every part of the country.

Strength and durability are considered key features of SVK slates. Our slate range is an economical, authentic and easily installed alternative to the natural slate. With environmentally friendly systems and technologies in place, SVK ensures that clients are able to design and build homes aesthetically pleasing and in harmony with the local environment.

Montana and Ardonit fibre-cement slates and their fittings are manufactured in accordance with the requirements of the European Standard EN 492.

#### 1.1 SCOPE

Montana and Ardonit slates are used for roofing (pitch 15° or greater and less than 75°) and cladding (a pitch of 75° or more). All conservations must be applied in accordance with the technical data and the national standards and regulations. The guarantees and warranties given with SVK Slates are conditional upon adherence to the instructions given in the fixing manual.

#### 1.2 COMPOSITION AND MANUFACTURE

The Montana and Ardonit slates are small size double pressed fibre-cement flat sheets, composed of Portland cement, organic fibres of superior quality, mineral additives and water.

The natural colour of the slates is grey. The front and the sides of the slates are finished with a multi-layer acrylic based coating. In order to prevent moss growth, special moss inhibiting constituents are added to the coating. The underside of the slates is treated with a one layer coating and a colourless water-repellent layer. This finishing offers optimal protection against all weather conditions.

Environmentally friendly:

SVK is aware of its environmental responsibilities. Excess production water is recycled and reused. Also waste material and cuttings are reused in production. The slates are coated with a water based coating.

### 1.3 PRODUCT RANGE

#### 1.3.1 SLATES

There are basically 4 slate ranges:

- Montana textured slates have a textured surface with dressed edges.
- Montana smooth slates have a smooth surface with dressed edges.
- Ardonit textured slates have a textured surface with square edges.
- Ardonit smooth slates have a smooth surface with square edges.

SVK is entitled to remove or add colours without prior warning. The colour is measured according Cielab. The tolerance is:  $\Delta E^* \pm 1,00$ .

**Important: Only slates with the same production date should be placed on the same roof/facade surface. Slates with different production dates should not be installed on the same roof/facade surfaces.**

### Montana textured slates

(with textured surface and dressed edges, available in Blue-black and Welsh blue)

Size **60/30** cm  
Production dimensions **595/295** mm  
Provided with 3 holes for vertical double lap slating with 10 cm head-lap

Weight: 1.48 kg



Size **60/60** cm  
Production dimensions **595/595** mm

Weight: 2.95 kg

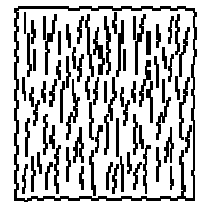

### Montana smooth slates

(with smooth surface and dressed edges, available in Blue-black)

Size **60/30** cm  
Production dimensions **595/295** mm  
Provided with 3 holes for vertical double lap slating with 10 cm head-lap

Weight: 1.48 kg

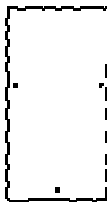

Size **60/60** cm  
Production dimensions **595/595** mm

Weight: 2.95 kg

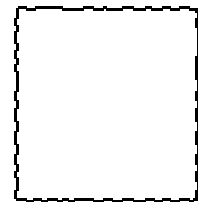

### Ardonit textured slates

(with textured surface and square edges, available in Blue-black)

Size **60/30** cm  
Production dimensions **600/300** mm  
Provided with 3 holes for vertical double lap slating with 10 cm head-lap

Weight: 1.53 kg



Size **60/60** cm  
Production dimensions **600/600** mm

Weight: 3.06 kg

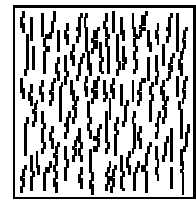

### Ardonit smooth slates

(with smooth surface and square edges, available in Blue-black and Premium black)

Size **60/30** cm  
Production dimensions **600/300** mm  
Provided with 3 holes for vertical double lap slating with 10 cm head-lap

Weight: 1.53 kg

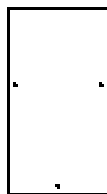

Size **60/60** cm  
Production dimensions **600/600** mm

Weight: 3.06 kg

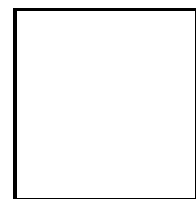

*The dressed edges and the textured surface are portrayed schematically, not realistically.*

The product range brochure is available from SVK.



**1.3.2 ACCESSORIES**

**1.3.2.1 Half round ridge**

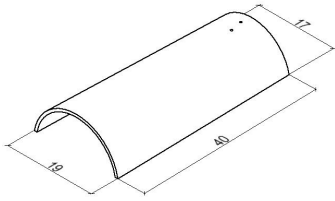

Number per m: 3.03  
 Effective length: 33 cm  
 Weight per piece: 1.42 kg  
 (Minimum roof pitch: 35 °)  
 Outer measurements in cm

**1.3.2.2 Half round start end for half round ridge**

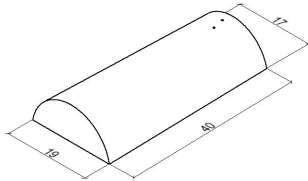

Effective length: 33 cm  
 Weight per piece: 1.48 kg  
 Outer measurements in cm

**1.3.2.3 Half round stop end for half round ridge**

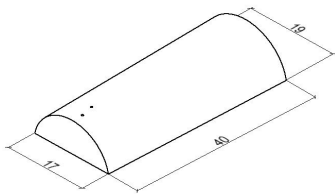

Effective length: 33 cm  
 Weight per piece: 1.48 kg  
 Outer measurements in cm

**1.3.2.4 Roll-top ridge type A**

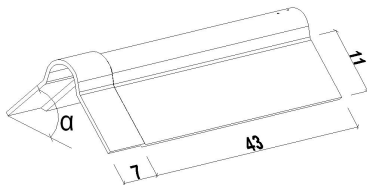

Number per m: 2.33  
 Effective length: 43 cm  
 Weight per piece: 1.82 kg  
 Roof pitch  $\alpha$ : 30° (ridge angle 120°)  
 45° (ridge angle 90°)  
 Outer measurements in cm

**1.3.2.5 Start end for roll-top ridge type A**

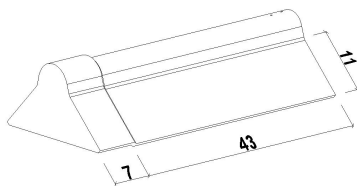

Effective length: 43 cm  
 Weight per piece: 1.90 kg  
 Outer measurements in cm

**1.3.2.6 Stop end for roll-top ridge type A**

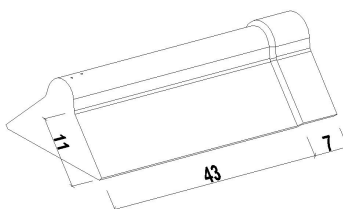

Effective length: 43 cm  
 Weight per piece: 1.90 kg  
 Outer measurements in cm

### 1.3.2.7 Plain angle ridge type B

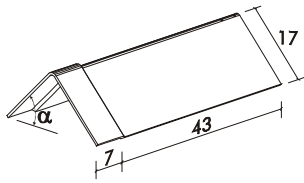

Number/m: 2.33  
 Effective length: 43 cm  
 Weight/piece: 2.00 kg  
 Roof pitch  $\alpha$ : 25° (= ridge angle 130°)  
 30° (= ridge angle 120°)  
 40° (= ridge angle 100°)  
 45° (= ridge angle 90°)

Outer measurements in cm

### 1.3.2.8 Start end for plain angle ridge type B

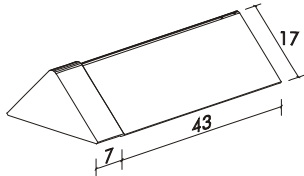

Effective length: 43 cm  
 Weight/piece: 2.10 kg  
 Outer measurements in cm

### 1.3.2.9 Stop end for plain angle ridge type B

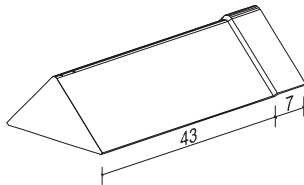

Effective length: 43 cm  
 Weight/piece: 2.10 kg  
 Outer measurements in cm

### 1.3.2.10 Verge slate

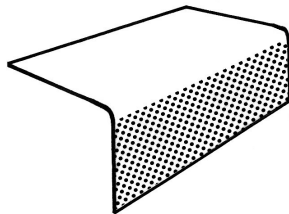

Weight/piece: 0.96 kg  
 Head-lap: subject to exposition and roof pitch.  
 The verge slates are placed on top of the regular slates.

Head-lap (cm)	Number/m
10	3.33
11	3.45

### 1.3.2.11 Fibre-cement ventilation slate

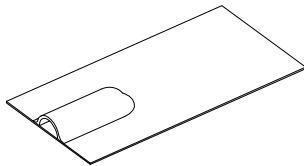

Size: 60 x 30 cm  
 Weight: 1.80 kg  
 Ventilation section: ca. 45 cm<sup>2</sup>

To achieve ventilation for the space below, an opening must be made in the underlying slates at the same height of the opening of the ventilation slate.

**1.3.3 EXTRA ACCESSORIES AND FIXINGS**

**1.3.3.1 Polypropylene comb filler**



Length: 100 cm  
Colour: black

**1.3.3.2 Synthetic ventilation under-ridge**



Length: 5 m/roll  
Width: 30 cm  
Ventilation section: 200 cm<sup>2</sup>/m  
Colour: black

**1.3.3.3 Slate nail**



**1.3.3.4 Slate nail – crenelated**



**1.3.3.5 Disc rivet**



**1.3.3.6 Ridge clip**



**1.3.3.7 Drive hook**



**1.3.3.8 Drive hook with hump**



**1.3.3.9 Drive hook with crimped shank**



The drive hooks are available in the following materials: copper, stainless steel and black stainless steel.



## 1.4 PRODUCT QUALITY

### 1.4.1 MECHANICAL AND PHYSICAL CHARACTERISTICS

Dimensions		Tolerances
Length	200 – 600 mm	± 3 mm
Width	200 – 600 mm	± 3 mm
Thickness	4 mm	- 0,4 mm / + 1,0 mm
Squareness	≤ 2 mm	≤ 2 mm

Mechanical characteristics		Norm
Bending moment		EN 492
$h \leq 350$ mm	30 Nm/m	
$350 < h \leq 450$ mm	40 Nm/m	
$450 < h \leq 600$ mm	45 Nm/m	
Elasticity modulus (wet)	ca. 16.000 N/mm <sup>2</sup>	
Thermal linear expansion coefficient $\alpha$	$7,5 \times 10^{-6}$ m/mK	

Durability		
Water impermeability	No water drops	EN 492
Wet-dry cycles	$L \geq 0,75$	
Warm water	$L \geq 0,75$	
Frost-thaw cycles	$L \geq 0,75$	
Warm-rain cycles	OK	

Reaction to fire		
Class	A2-s1, d0	EN 13501-1

Physical characteristics		
Density (ovendry)	$\rho \geq 1.700$ kg/m <sup>3</sup>	
Weight (at moisture content: 12%)	8 kg/m <sup>2</sup>	
Coefficient of heat conductivity: $\lambda$	0,72 W/mK	
Water uptake (coated slates)	< 4% (weight)	
Paint adhesion	Class 0	DIN EN ISO 2409

### 1.4.2 QUALITY CERTIFICATES



CSTB  
84 avenue Jean Jaurès -  
Champs sur Marne  
F-77447 Marne-la-Vallée



Ardoises en fibres ciment  
<http://evaluation.cstb.fr>

### 1.4.3 WARRANTY

SVK warrants Ardonit and Montana slates and accessories in fibre cement insofar as the storage, treatment, construction and maintenance of the SVK slates and accessories take place in accordance with the rules and the guidelines of our most recent applicable technical specifications, all of which under normal atmospheric conditions and conditions of use. The warranty conditions which must be met in order for the warranty to be fully applicable, are mentioned in the warranty certificate. This certificate is available on request.

The site-work must be in accordance with the procedures and requirements of the BS 5534: Code of Practice for Slating and Tiling, the BS 8000-6: Workmanship on Building Sites and with the prescriptions of the manufacturer mentioned in these technical data.

## 2 DESIGN CRITERIA

### 2.1 RAIN AND SNOW RESISTANCE

The UK has a climate where there is a high risk of severe driving rain.

SVK slates are one of the most watertight roof coverings available and offer a full protection from water ingress under normal conditions.

In abnormal weather conditions<sup>(1)</sup> however, water penetration through the slates is sometimes unavoidable.

It is essential to avoid/minimise the risk of water ingress by careful design, detailing and workmanship, attuned to the local exposure conditions.

It is important that the exposure to local wind driven rain of the construction site is assessed.

The following figure details two simplified categories of exposure based on driving rain. This map should be used when designing buildings **up to 12 m ridge height** above ground level.

If necessary (higher buildings and exceptionally exposed sites) special precautions must be taken, which have to be adapted to the specific situation.

The figure below shows the exposure zones as divided by BS 5534.

Roofing products, fittings and accessories, when laid and fixed on a roof, perform in different ways to resist snow and rainwater penetration. The mechanisms of rainwater ingress can include: capillary attraction and water creep, driving rain, deluge rain and flooding, raindrop bounce, surcharging of rainwater on laps on long rafter roofs and wind-driven snow.

At present, the UK does not have a British Standard performance test for rain or snow resistance to assess the pitch and lap performance of pitched roofing products. Therefore the guidance given for rain resistance is in the form of prescriptive recommendations, which are based on experience SVK has gained from over 100 years supplying roofing products (over 30 years in the UK).

The macroclimate and microclimate acting physically and/or chemically on a roof might affect the appearance of the roof. If this is an important part of the design, our advice should be sought.

Atmospheres with high sulphur or nitrogen acid gasses created in industrial areas or by fuel combustion can attack and erode some roofing products that contain alkali salts. Similar effects can occur in marine and coastal locations where high salt content and humidity can occur.

When the applicable driving rain exposure category (see figure) is uncertain, more precise information is available in BS 8104. If this still doesn't suffice a driving rain category of 56.5 l/m<sup>2</sup> per spell or greater should be used.

---

(1) **Abnormal weather conditions:** on elevated sites, near the coast, in localities where heavy snowfalls are commonly experienced or in conditions of severe exposure.

Figure 2 UK map of categories of exposure to driving rain

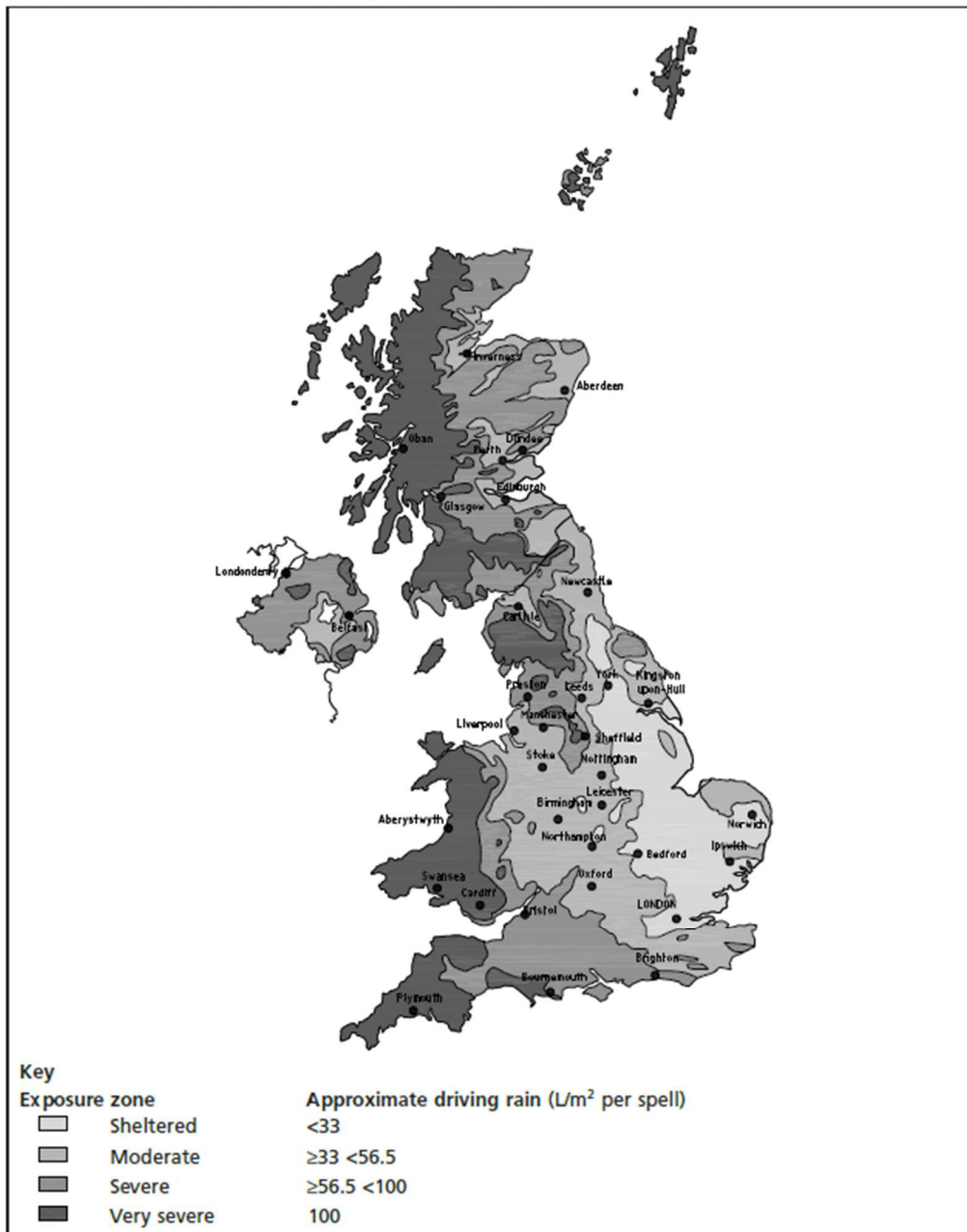

## 2.2 SAFETY

To lay a roof is a hazardous activity and statutory legislation applies to all types of roofing work. Particular attention is drawn to the *Health and Safety in roof work (HSG)* regulations and other legislation setting out the duties of owners, employers and employees in relation to the construction and maintenance of buildings. Owners, designers, building contractors and roofers should ascertain the latest legislation in force at the time of building.

**Under no circumstance is it allowed to walk directly on the slates.** Where access is required, ladders or crawl boards should be used.

## 2.3 TRANSPORT AND STORAGE

Slates and accessories should be transported, unloaded and handled with care to avoid damage, soiling or breakage.

The slates are bundled in small packs and delivered on pallets, wrapped in shrink foil. This wrapping only prevents the slates from sliding during transport, it does not offer adequate protection against weather circumstances. Covered transport is therefore obligatory.

Store the slates on a dry, firm and level surface, in a covered and thoroughly ventilated area safe from all traffic, in warehouse as well as on the building site. Maximum stack height for storage is 4 pallets.

In case there is no possibility to store the slates in a covered area on site, the shrink foil has to be removed or partially opened and the pallets must be covered at all times by a watertight but vapour permeable tarpaulin. Condensation and rainwater ingress between stacked slates must absolutely be prevented, to avoid efflorescence.

In case of storage for a prolonged period we strongly advise to partially open up the shrink film, even in case of storage under cover, to prevent condensation under the foil, and thus efflorescence.

Remainders of a pallet of slates, that will not be used shortly, are stocked as described above, either vertically on two battens or horizontally on a level and perfectly dry surface. When transporting and manipulating building materials, the legislation concerning lifting and hoisting must be respected at all times.

Underlays, battens and counterbattens, accessories and all other materials needed for the roofing work must be stored in accordance with the regulations in British Standards and the product storage prescriptions.

Avoid staining and wear gloves when handling the slates. Avoid stains of glue, silicone, polyurethane foam, adhesive tape, render as these can leave irremovable stains.

## 2.4 CUTTING AND DRILLING SLATES

### 2.4.1 GENERAL

When cutting slates, measures to reduce the effect of dust should be taken in accordance with the relevant local regulations.

Avoid drilling and cutting dust sediment on the slate surface. In case there is dust on the slates, it should be removed immediately by means of a soft, dry and pure micro-fibre cloth or a soft brush, before the slates are processed any further, exposed to rain or restacked. Cement dust that is left on the slates surface causes unwanted visual effects on the slates after their exposition to weather circumstances.

### 2.4.2 CUTTING

SVK slates can be cut in different ways:

- Score the face of the slate with a scribing tool and snap over a straight edge.
- Cut with a slate guillotine. Place the slate face side up, because the guillotine produces a chamfered cut edge.
- Use a hand slate cutter.
- It is not recommended to use angle grinders, because of their high dust production levels.
- To cut large quantities of slates, use a bench saw with diamond dusted blade and provide dust extraction.
- Remove cutting dust immediately from the slates.

### 2.4.3 DRILLING

To drill additional holes, up to maximum ten slates can be stacked and holes be drilled with a 4.5 mm sharpened steel drill bit, suitable for fibre-cement.

It is also possible to punch additional holes. Remove drilling dust immediately from the slates.

## 2.5 FIXINGS

### 2.5.1 GENERAL

The fixing materials have to be made out of corrosion-resistant material such as copper, stainless or galvanised steel. The type of slate, the kind of roof structure and the slating method used determines the nature and number of the fixings.

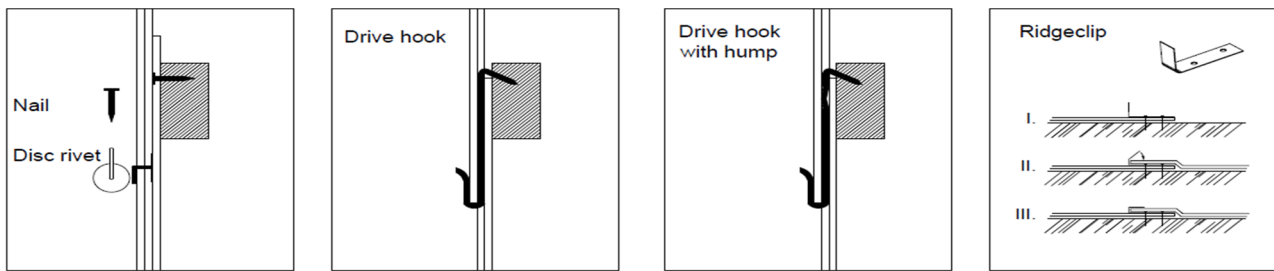

In general, the slates are fixed with two nails and a disc headed copper rivet. The rivet holds together the tail, on the centre-line of each slate, to the two slates in the course below, through the gap between them.

The nails must comply with BS EN 1202-2 and 3. The nail shank should be **not less than 2,65 mm** and the length should be approximately 30 mm so a **penetration of at least 15 mm** into the batten is provided.

Use disc rivets with stem of minimum 19 mm long and diameter less than 2 mm. The disc base of the disc rivet should be formed of 0,5 mm thick copper sheet and have a diameter of minimum 19 mm. Use appropriate disc rivets to obtain sufficient uplift resistance. Disc rivets are bent downwards; not too tight, so some movement of the slate is still possible.

The exposure conditions, the roof pitch and the height of the building determine the requirements for the fixing of the slates.

The number of applicable Fixings can be found in the chapter about slating systems (see § 3).

Some remarks:

- building height  $\leq 12$  m;
- in the edge areas or the areas surrounding roof punctures, all slates within 1 m have to be fastened with at least 2 nails.

The Fixings and other metal accessories, that are used for Fixing and finishing, must be made from a metal that is compatible with the slates and accessories.

### 2.5.2 FIXING METHODS

#### 2.5.2.1 Centre-nailing

The slates are fixed with two nails close to the side edge (20 mm to the inner edge of the nail hole) of the slate and positioned immediately above the head of the slates below.

- When nailing the slates the holes are pre-pinned with a diameter greater than the slating nail.
- It's better to use crenelated nails (see § 1.3.3.4) than the normal slating nails (see § 1.3.3.3) because of a higher pullout-resistance.
- 1 slate should be fixed with minimum 2 nails.
- Slates for vertical work need to be centre-nailed.
- Head fixing and shoulder fixing are not recommended because they do not have the benefit of a long cantilever arm above the nails in resisting wind uplift as in centre-nailing.
- Nails should be fixed in the middle of the battens.

#### 2.5.2.2 Hook-fixing

Though this is not very customary in the UK, this fixing method is a very good alternative to the nail fixing of slates and is covered by BS 5534.

When applying hook fixing:

- Hooks intended for slating should be drive slate hooks formed from stainless steel wire conforming to BS EN 10088-3, grade 316.
- The hooks must never be pushed in order to counteract as much as possible capillary action and creep.
- The use of wrap hooks is not recommended by BS 5534.
- Crimped hooks should be used at pitches of 30° or less.
- Length of the hook = Greater than the head-lap +5.0 mm; and less than the head-lap +10 mm
- Hooks with crimped shanks reduce the capillary rise of water at the perpendicular joints between slates and are suitable for all roof pitches between 25° and 90°.
- Straight shank hooks should not be used at roof pitches below 30°, instead crimped hooks should be used.
- The hook shank diameter should be greater than 2.7 mm and smaller than the minimum slate thickness.
- Hooks should not be used at pitches less than 25°.
- When hook fixing, a minimum of two nail fixings in addition to the hooks should be used at eaves, ridges and top abutments and, to prevent lateral drift, at verges, hips, valleys and side abutments.

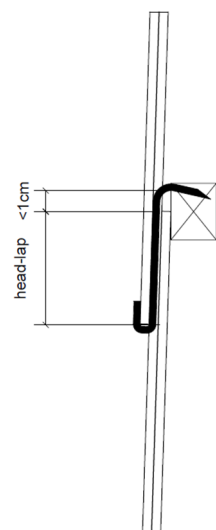

### **2.5.2.3 Copper tail rivet fixing**

The copper tail rivet is positioned in the centre of the slate, close to the leading edge, so the top slate is clamped to the two lower slates. It is slid up in the gap between the lower slates and goes through a pre punched hole in the top slate. The pin is bent over to lock the slates and the rivet together. The British Standard 5534 recommends that the gap between the slates should not be wider than 5 mm, when a rivet with a base diameter of 19mm is used. This makes that up to 8mm of the disc lays under each of the lower slates. If the slates are laid with a gap greater than 5mm, there is a risk that the rivet will be pulled through the gap during strong winds.

The rivet pin has to be sufficiently long, so it can be bent over far enough at right angles onto the top surface of the top slate.

## **2.5.3 COMPLEMENTARY PRODUCTS**

### **2.5.3.1 Fixing accessories**

All fixing accessories, used at junctions or finishings, must be of a material that is compatible with the fibre cement slates and their fixings. Avoid staining, corrosion or other reactions, leading to damage.

### **2.5.3.2 Dry roofing products - Mortar mix.**

Try to avoid mortar mix. SVK strongly advises to use dry roofing products and systems instead. Use systems offering a proven resistance to wind load, driving rain and durability.

If however mortar mix is used, plasticizing admixtures must be added, in accordance to the advice of their manufacturer.

Wherever problems occur, which could be caused by the fact that the mortar fixing prevents the normal working of the fibre cement roofs or accessories under weather circumstances, SVK guarantee cannot be invoked.

### **2.5.3.3 Flashings, junctions and projections**

Flashings and junctions must be detailed to prevent the entry of rainwater.

The integrity of the underlay as a barrier to wind and water ingress should be maintained around all projections.



## 2.6 COVERING

The waterproofness of a slate roof depends on several factors, of which the most important ones are capillarity, weather conditions, length of the roof side (from gutter to ridge) and roof pitch. These factors together determine the slate head-lap.

### 2.6.1 CAPILLARITY

Capillarity is the phenomenon where when two plates are pressed firmly together, fluid will rise between them.

The harder the slates are pressed against each other, the higher the rain will rise between them. The maximum gauge difference between the slates is 25 mm, and this regardless of the fact that they are placed perpendicular or sloping. The actual rise between the slates varies depending on the inclination they are given. It rises if the roof pitch shrinks. Driving rain and dust building between the slates strengthen the capillary effect.

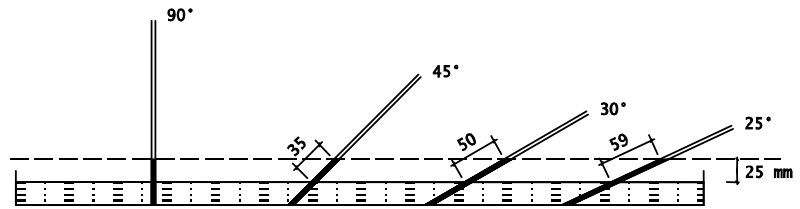

The drawing above shows that the smaller the inclination the bigger the head-lap needs to be. To minimise the risk of water infiltration by capillary action, we advise to use hooks instead of nails for fixing slates, because with hook fixing the slates are less close-fitting.

### 2.6.2 WEATHER CONDITIONS

When a roof surface is strongly exposed to the predominant winds, the wind will try to hold up the water that flows down at the bottom edge of the slates and then propel it underneath. In dry weather dust is blown between the slates and in the joints. These factors influence the capillary process greatly. The measure in which a roof is protected or exposed to heavy wind and rain can only be determined at the site (see 2.1), taking into account several factors:

- screening by surrounding buildings;
- hilly or plane landscape;
- sea or mountain region.

### 2.6.3 LENGTH OF THE ROOF SURFACE

Because all the water that falls on the roof flows to the gutter, it's obvious that the water layer gets thicker the closer you get to the gutter. The fact that infiltrations usually occur at the bottom part of the roof proves this thesis. The longer the roof surface (from gutter to ridge) the bigger the risk.

The amount of water that falls on a roof, is however not determined by the actual roof length, yet is proportional with the horizontal projection of it. E.g. a roof of 45° with an actual length of 7 m has a horizontal projection of 5 m (see table in § 2.6.4). Experience has taught us that a horizontal projection of 5 m is the limit to where a normal head-lap may be applied, above that the head-lap needs to be increased.

### 2.6.4 ROOF PITCH

When discussing the capillarity (see § 2.6.1) it was demonstrated that the actual rise of the capillary water grew as the inclination shrank. The smaller the inclination, the more the actual roof length approaches the horizontal projection. Moreover the speed at which the water flows down the roof gets slower when the roof has a fainter inclination. The flowing off takes longer which makes the water layer even thicker. Add to that the fact that with smaller inclinations the side lap, and consequently the width of the slate, start playing a bigger role, it is without a doubt clear that for the watertightness of a slate roof, the roof pitch is a very important factor. Consequently with lower roof pitches a bigger head-lap is necessary to guarantee the watertightness.

The minimum pitch is dependent on the roofing system used (see § 3).

The roof pitch can be represented in 2 ways:

- in degrees;
- in cm per meter (or %).

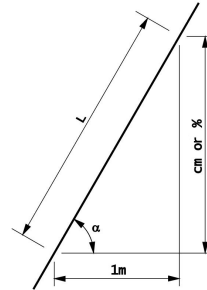

Comparison degrees – percentages:

$\alpha$ (degrees)	%	Length of roof surface L per meter horizontal projection	$\alpha$ (degrees)	%	Length of roof surface L per meter horizontal projection
20	36	1.064	48	111	1.494
21	38	1.071	49	115	1.524
22	40	1.079	50	119	1.556
23	42	1.086	51	123	1.589
24	45	1.095	52	128	1.624
25	47	1.103	53	133	1.662
26	49	1.113	54	138	1.701
27	51	1.122	55	143	1.743
28	53	1.133	56	148	1.788
29	55	1.143	57	154	1.836
30	58	1.155	58	160	1.887
31	60	1.167	59	166	1.942
32	62	1.179	60	173	2.000
33	65	1.192	61	180	2.063
34	67	1.206	62	188	2.130
35	70	1.221	63	196	2.203
36	73	1.236	64	205	2.281
37	75	1.252	65	214	2.366
38	78	1.269	66	225	2.459
39	81	1.287	67	236	2.559
40	84	1.305	68	248	2.669
41	87	1.325	69	261	2.790
42	90	1.346	70	275	2.924
43	93	1.367	75	373	3.864
44	97	1.390	80	567	5.759
45	100	1.414	85	1.143	11.474
46	104	1.440	90	-	-
47	107	1.466			

**Attention:**

**The roof pitch should be taken to be equal to the rafter pitch but the actual pitch of the slates when laid is less than the roof pitch.**

Because the slates lift each other up slightly, there is a difference between the roof pitch and the slate pitch. This may be of importance when determining the head-lap in border cases. In chapter 3 about the slating systems, **the minimum pitch of the slates** is mentioned.

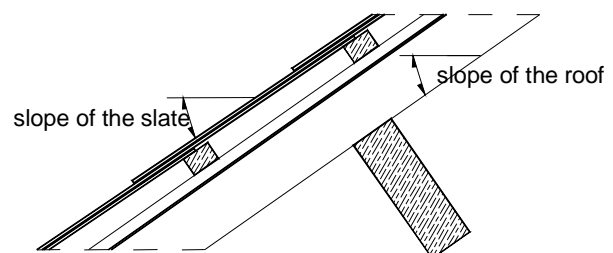

## 2.7 MAINTENANCE

Just like any other roofing material, slates are subject to pollution and ageing. In time dust and atmospheric pollution sedimentation appear on the roofing. Moss is also hard to prevent and it does not depend on the type of roofing, moss can attach itself to any kind of material.

Even though there is a moss-inhibiting component in the coating of the slates, external factors play a large part in the roof becoming green or not. It actually aren't the slates that become green, it's the dust and the dirt on the slates that is an excellent soil for moss and algae.

Pay attention to safety during these works, national standards and local regulations must be followed.

### 2.7.1 CAUSE OF THE POLLUTION

The intensity of the moss development is highly dependable on:

- Roof orientation
  - Mosses mainly develop on the parts of the roof that are exposed to little or no sunshine, such as the roof surfaces facing north or those that are permanently lying in the shadow.
- Ventilation between underlay and slates
  - Good ventilation ensures that the roof covering remains damp less long. Mosses and algae develop on the sand and dust particles that attach themselves easiest to a wet surface. A good ventilation between the underlay and the slates contributes significantly to the roof surface drying up more quickly and consequently slows down moss development.
- The presence of trees and plants in the immediate environment
  - The presence of trees and plants in the vicinity naturally has a negative effect.
- Acid rain
  - The acid rain forms an acid environment on the roof in which moss and algae thrive.

The slates becoming green has no effect whatsoever on the quality of the slates. But to ensure the appearance, the life span and watertightness of the roof, the standards and prescriptions recommend regular maintenance.

This can be done by a firm specialised in cleaning roofs. If you want to do it yourself, there are chemical products on the market to clean the roof surface.

### 2.7.2 METHOD

#### 2.7.3 MECHANICAL CLEANING

The moss is removed by brushing the roof with a hard, but not a metal, bristle. Be sure not to scratch the surface of the materials as dust particles adhere themselves quicker on a rough surface, which aids moss development.

Finally the roof surface is thoroughly rinsed. Be sure to prevent dust and moss from ending up in the rainwater-well.

A second possibility is the cleaning of the roof with a high-pressure washer. These works are preferably carried out by a specialised firm because of the risks it holds.

#### 2.7.4 CHEMICAL CLEANING

When the roof is fully dried out, a good moss detergent is applied that penetrates the material sufficiently to destroy all moss and algae buds.

Depending on the product used it may be necessary to, after sufficient absorption of the product, remove the remaining pieces of moss from the roof by bristling or rinsing. Detach the drains to prevent these moss remains and the applied product from entering the water drainage system.

Products that might affect the slates, their coating or the metal parts used for roofing (nails, disc rivets, hooks, gutters, etc.) are not to be used.

### 3 SLATING SYSTEMS

#### 3.1 VERTICAL DOUBLE-LAP (ROOF - FACADE)

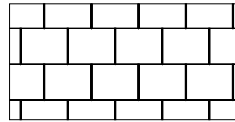

##### 3.1.1 PRINCIPLE

Vertical, double-lap slating is the common way of working and is suitable for all rectangular slates. The slates are laid in broken bond. Double-lap means that each row of slates is partly covered by the two rows above. The head-lap is the distance by which the upper course of slates provides a lap with the next but one course below.

This way, each slate can be divided into three areas (see figure below):

- visible area;
- single lap area;
- double-lap area (= head-lap).

The double covered part is called the head-lap. The height of each of the two other parts equals the batten distance and is determined as following:

$$L(\text{batten distance}) = \frac{H(\text{slate height}) - A(\text{headlap})}{2} = P(\text{visible area}) = \text{single lap area}$$

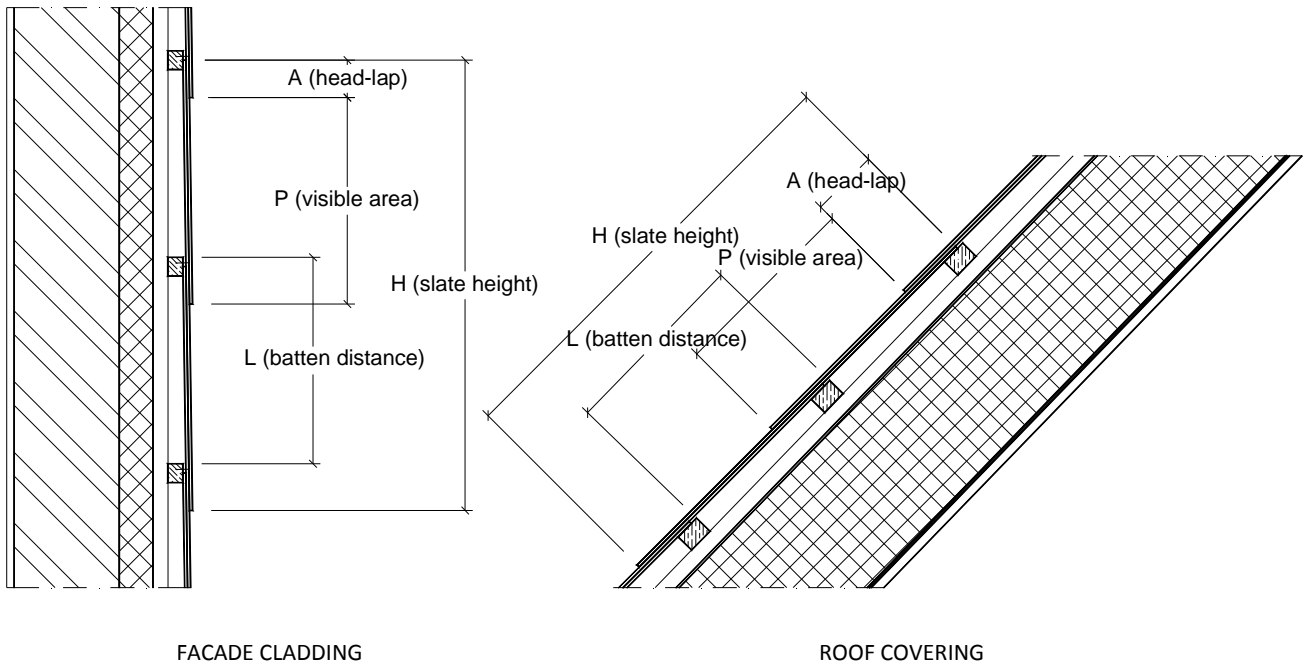

The recommendations apply for rafter lengths of maximum 9m in driving rain exposure of less than 56.5 l/m<sup>2</sup> per spell and 6 m in driving rain exposures of 56.5 l/m<sup>2</sup> per spell or more.

The recommendations for laps given below might not be adequate for roof pitches of **30° or less**:

- for driving rain exposure of less than 56.5 l/m<sup>2</sup> per spell, for rafter lengths greater than 9m;
- for driving rain exposure of 56.5 l/m<sup>2</sup> per spell or greater, for rafter lengths greater than 6m.

In this case the placement of a sub-roof and/or intermediate gutters should be considered.

The minimum slate width is determined by several factors: the slate length, the head-lap, the roof pitch, the driving rain exposure and the distance from the side edge of the slate to the inner nail hole. Calculation needs to be done according to BS 5534.

### 3.1.2 MINIMUM HEAD-LAP – ROOF PITCH

The minimum vertical head-lap (A) in mm (according to BS 5534) for following roof pitches is:

Roof pitch [°]	Minimum head-lap [cm]	
	< 56.5 l/m <sup>2</sup> per spell rafter length ≤ 9 m	≥ 56.5 l/m <sup>2</sup> per spell rafter length ≤ 6 m
22.5	11	-
25	10	12
27.5	9	11
30	8	10
35	7	9
40	6	8
45 - < 75	6	7
≥ 75	5	5

For special applications with lower roof pitches, SVK advice should be sought.

For pitches between 15° and 22.5° please contact SVK.

### 3.1.3 FIXING

- Slates greater than 40 x 20 cm are fixed with nails and have a disc rivet at the tail.
- Hooks should not be used for pitches less than 25°.
- Crimped hooks should be used at pitches of 30° or less.

Drive hooks are placed between 5mm and 1 cm higher than the top edge of the slates. This means that the hooks are between 5mm and 1 cm longer than the vertical lap. It is advisable to only use stainless steel hooks.

### 3.1.4 NUMBER AND DIMENSIONS

Format [cm]	Head-lap A [cm]	Appx. batten gauge L [cm]		Appx. pieces per m <sup>2</sup>		Appx. weight [kg/m <sup>2</sup> ]	
		Ardonit	Montana	Ardonit	Montana	Ardonit	Montana
60 x 30	5	27,5	27,25	12,0	12,3	18,3	18,1
	10	25,0	24,75	13,2	13,5	20,1	20,0
	11	24,5	24,25	13,4	13,8	20,5	20,4
60 x 60	5	27,5	27,25	-	-	-	-
	10	25,0	24,75	-	-	-	-
	11	24,5	24,25	-	-	-	-

The numbers are calculated with a **perpendicular joint of 4 mm**.

### 3.1.5 DIMENSIONS OF THE BOTTOM SLATES AND THE POSITION OF THE BOTTOM ROW BATTENS

The height of the first row of slates, 1<sup>st</sup> under-eaves course:  $H_1 = L$

The height of the second row of slates, 2<sup>nd</sup> under-eaves course:  $H_2 = L + A$

The bottom slates are fixed with 2 nails.

Batten distances are calculated as following:

$$L_1 = L - B \quad \& \quad L_2 = L + A - B$$

A = head-lap

B = overhang of the bottom slates past the lowest batten (max. 5 cm)

L = batten gauge centre-to-centre, depending on slate height H and head-lap A

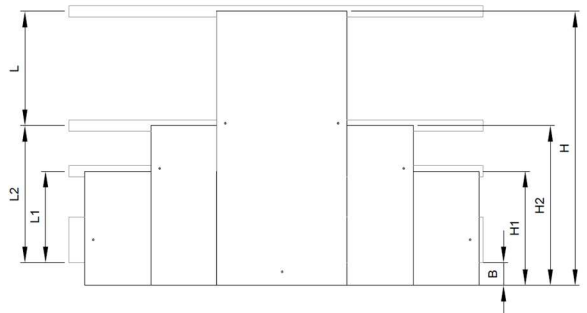

Height slate H [cm]	Head-lap A [cm]	Ardonit						Montana					
		L [cm]	H <sub>1</sub> [cm]	H <sub>2</sub> [cm]	L <sub>1</sub> [cm] (B = p. ex. 5 cm)	L <sub>2</sub> [cm] (B = p. ex. 5 cm)	L [cm]	H <sub>1</sub> [cm]	H <sub>2</sub> [cm]	L <sub>1</sub> [cm] (B = p. ex. 5 cm)	L <sub>2</sub> [cm] (B = p. ex. 5 cm)		
60	5*	27,5	27,5	32,5	22,5	27,5	27,25	27,25	32,25	22,25	27,25		
	10	25,0	25,0	35,0	20,0	30,0	24,75	24,75	34,75	19,75	29,75		
	11	24,5	24,5	35,5	19,5	30,5	24,25	24,25	35,25	19,25	30,25		

### 3.2 HORIZONTAL DOUBLE-LAP (ROOF - FACADE)

#### 3.2.1 PRINCIPLE

This method is a variation to the double-lap method. The rectangular slates are placed horizontally here. This method can be applied for both **facade cladding** and **roofing** in normal situations.

The minimum pitch is **27.5°**, measured on the slate.

The recommendations apply for rafter lengths of maximum 9m in driving rain exposure of less than 56.5 l/m<sup>2</sup> per spell and 6 m in driving rain exposures of 56.5 l/m<sup>2</sup> per spell or more.

The recommendations for laps given below might not be adequate for roof pitches of **30° or less**:

- for driving rain exposure of less than 56.5 l/m<sup>2</sup> per spell, for rafter lengths greater than 9m;
- for driving rain exposure of 56.5 l/m<sup>2</sup> per spell or greater, for rafter lengths greater than 6m.

In this case the placement of a sub-roof and/or intermediate gutters should be considered.

The minimum slate width is determined by several factors: the slate length, the head-lap, the roof pitch, the driving rain exposure and the distance from the side edge of the slate to the inner nail hole. Calculation needs to be done according to BS 5534.

#### 3.2.2 MINIMUM HEAD-LAP – ROOF PITCH

- The minimum vertical head-lap [A] in mm (according to BS 5534) for following roof pitches is:

Roof pitch [°]	Minimum head-lap [cm]	
	<56.5 l/m <sup>2</sup> per spell rafter length ≤ 9 m	≥56.5 l/m <sup>2</sup> per spell rafter length ≤ 6 m
27.5 - 30	10	11
30 - 75	10	10
≥ 75	5	5

#### 3.2.3 FIXING

The slate 60x30 is fixed with 3 jagged nails.

For the position of the middle fixing, one should take the driving wind direction into account. The slates need to be pre-pinned (position of the holes, see drawings in table § 3.2.5).

#### 3.2.4 DIMENSIONS OF THE BOTTOM SLATES AND THE POSITION OF THE BOTTOM ROW BATTENS

The height of the first row of slates, also called 1<sup>st</sup> under-eaves course:  $H_1 = L + A - 2.5 \text{ cm}$

The height of the second row of slates, also called 2<sup>nd</sup> under-eaves course:  $H_2 = L + A$

The bottom slates are fixed with 3 nails.

Batten distances are calculated as following:

$$L_1 = L + A - (B + 1 \text{ cm}) \quad \& \quad L_2 = H - B$$

A = head-lap

B = overhang of the bottom slates past the lowest batten (max. 5 cm)

L = batten gauge centre-to-centre, depending on slate height H and head-lap A

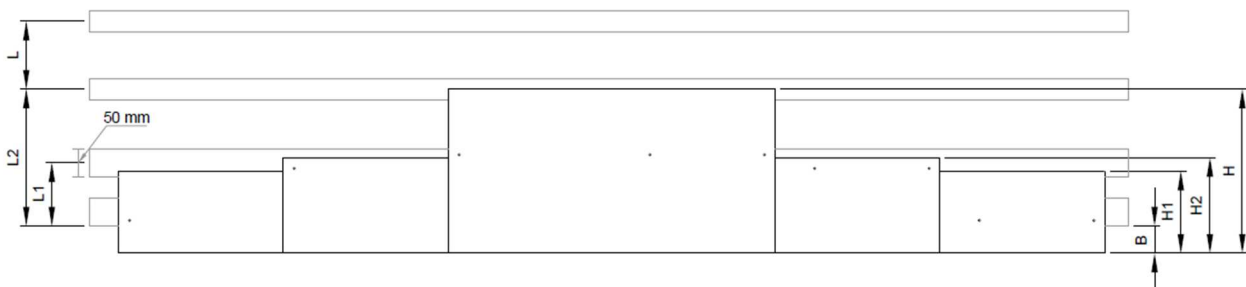

Height slate H [cm]	Head-lap A [cm]	Ardonit				
		L [cm]	H <sub>1</sub> [cm]	H <sub>2</sub> [cm]	L <sub>1</sub> [cm] (B = p. ex. 5cm)	L <sub>2</sub> [cm] (B = p. ex. 5cm)
30	5	12.5	15.0	17.5	11.5	25.0
	10	10.0	17.5	20.0	14.0	25.0
	11	9.5	18.0	20.5	14.5	25.0



### 3.2.5 NUMBER AND DIMENSIONS

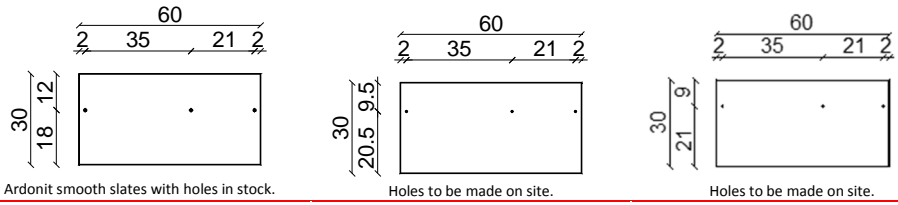

Head-lap [cm]	5	10	11
Visible surface W x H [cm]	60 x 12.5	60 x 10.0	60 x 9.5
Batten gauge centre-to-centre [cm]	12.5	10.0	9.5
Number of slates [pc/m <sup>2</sup> ]	13.25	16.56	17.43
Weight [kg/m <sup>2</sup> ]	20.26	25.3	26.33
Battens [m/m <sup>2</sup> ]	8.0	10	10.5

The numbers are calculated with a **perpendicular joint of 4 mm**.

### 3.3 OTHER SLATING SYSTEMS

For other slating systems, SVK advice should be sought.

## 4 CONSTRUCTION

### 4.1 ROOFING COMPONENTS

In this section SVK does not necessarily give complete information on all the different components and their properties. For further information we refer to the British Standards, which have to be respected at all times.

To allow a high quality and aesthetic slating, it is important that the roof structure is adequately designed and executed, according to all building regulations.

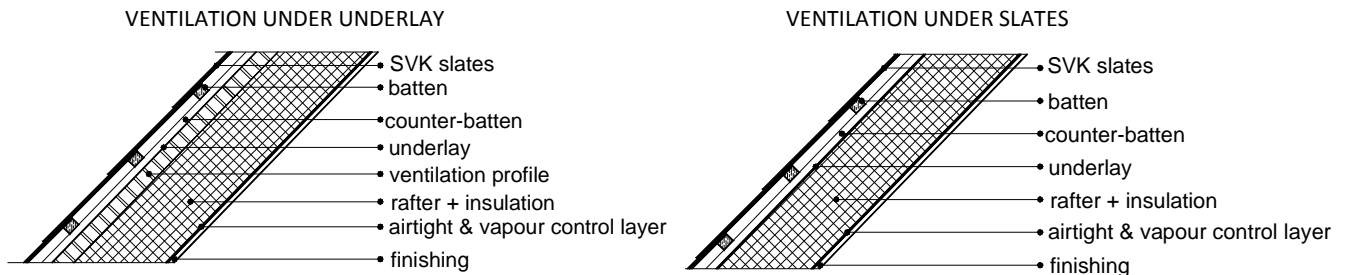

#### 4.1.1 SUPPORTING FRAMEWORK

The supporting framework of a slate roof is usually made out of purlins (girders) with rafters or trusses. Here you have to take in account the minimum roof pitch and the weight of the total roof.

The roof structure must be professionally designed so it can bear the roof covering and all extra loads (wind, snow, ...) acting on it, respecting the admissible deformations and tensions in the materials. The supporting framework has to retain its form.

Take into account the size of the slates when drawing up the design. The length and width of the roof surface are best to be seen as a multiple of slates, taking into account the head-lap, the ridge, the joint between the slates and possible facade slates. This way the number of slates that need to be cut can be reduced to a strict minimum.

#### 4.1.2 ROOFING UNDERLAY

Because the roof covering itself cannot offer a complete protection from water and dust, it is strongly advised, and often necessary, to install a watertight underlay, that evacuates all moisture out of the building structure.

This underlay also provides a barrier to minimise the effects of the wind load acting on the slates.

Always use a high quality underlay, with a high resistance and stiffness against wind uploads and all other forces. Use a damp open underlay, with good moisture absorption properties.

Install it carefully, in order to avoid any risk of contact with the underside of the slates, even in the worst conditions.

We refer to the BS 5534 for more information on the underlay.

#### 4.1.3 COUNTER-BATTENS

British Standards 5534 and 5250 determine whether counter-battens are required based on the combination between:

- Type of roof, cold or warm pitched roof;
- Type of used underlay, HR or LR underlay;
- Airtightness of the roof covering, air open or airtight covering;

Fibre cement slates are a relatively airtight, close fitting roof covering. When tight outer coverings are applied there is a risk of interstitial condensation on the underside of the underlay and the external covering. To minimize such risk BS 5250 advises a ventilated batten-space with counter-battens.

Furthermore, even though SVK slates are one of the most watertight roof coverings available and offer a full protection from water ingress under normal conditions, water and snow dust penetration through the slates in abnormal conditions is sometimes unavoidable, see chapter 2.1.

Due to these reasons SVK strongly advises to always use counter-battens as the purpose of the underlay isn't fully achieved until you apply counter-battens.

The space that is generated between the counter-battens has several functions:

- drain any infiltration water that may occur;
- allow ventilation to make sure the underlay, battens and slates are being aired, which gives them a longer life span;
- prevent moist from piling up against the slating battens;
- evening out the pressure between the outside air and the space underneath the slates, which reduces suction when it's very windy;
- reduce the risk of damaging the underlay during the construction of the roof.

The counter-battens are nailed coinciding with the rafters/trusses on top of the underlay.  
 The dimensions of counter-battens have to be sufficient to provide a ventilation gap as recommended in the BS 5250 and/or to provide a drainage path beneath the battens.  
 Nails for battens, counter-battens and underlay should conform to the relevant parts of the BS 1202.  
 The timber used for slating battens and counter-battens must be straight, preferably planed, and of equal thickness.  
 The topsides of the counter-battens have to lie in the same plane.  
 The centre-to-centre distance of the counter-battens depends on the underlying construction and decides the slating battens' distances.  
 Timber species, permissible characteristics and defects, preservative treatment, sizes and identification must comply with BS 5534.  
 The counter-battens have to be fixed with nails with a round plain shank of not less than 3,35 mm shank diameter and a penetration of minimum 40 mm. Spiral roll and annular shank nails may also be used.

#### 4.1.4 BATTENS

The battens are fixed, in straight lines, to the appropriate gauge (batten distance) depending on the slating system used.  
 The battens are parallel with the ridge (or at right angles to the line of drainage).  
 Battens should generally be continuous over not less than three supports.  
 Set out the battens, remembering to allow eaves slates to overhang the gutter to ensure water discharge into the gutter.  
 The recommended overhang for a 100 mm wide gutter is **45 mm to 55 mm**, measured horizontally from the fascia, tilting fillet or wall face.  
 For gutter with a different width, the overhang is the lesser of:

- 45 to 55 mm horizontally;
- the center-line of the gutter.

We advise to fix a vertical batten at the roof verge and at intersections.  
 Slating battens for roofing and cladding are the carrying element for the slates, which are fixed to the counter-battens with their widest side.

The section of the slating battens depends on the span of the counter-battens (usually also the span of the rafters).

The minimum timber batten sizes (width x depth):

- **38 x 25** mm for a span up to 450 mm
- **50 x 25** mm for a span up to 600 mm

Rafter centres exceeding 600 mm need structural calculation.

**Note:** These minimum sizes do not apply to battens used to support ridges, hips and valleys.  
 The end-bearing length should be not less than 17.5 mm.

The thickness of the bottom slating batten (usually a tilting fillet is used for this) is raised with the thickness of a slate (ca. 4 mm), to ensure that the bottom row of slates has the same roof pitch as the ones on top.  
 The topsides of the battens need to be placed in the same plane, to ensure a smooth roof surface. A small glitch can immediately result in a difference of level or create tensions in the finishing of the slates.  
 Timber species, permissible characteristics and defects, preservative treatment, sizes and identification must comply with BS 5534.  
 The battens have to be fixed with nails with a round plain shank of not less than 3.35 mm shank diameter and a penetration of minimum 40 mm. Spiral roll and annular shank nails may also be used.

#### 4.1.5 INSULATION, AIR AND VAPOUR TIGHTNESS

##### 4.1.5.1 Insulation

These days it is very common to insulate the roof space. Insulation thickness keeps increasing and, as a consequence, the temperature differences between the insulated and non-insulated areas of roof constructions are bigger.  
 This has led to an increased risk of condensation in the cold roof spaces.

In the UK, the space between insulation and underlay is often ventilated, whilst the space between underlay and slates is not. Although in the UK this is not the common way to construct a roof, SVK strongly advises to use a vapour permeable underlay and to ventilate the gap between underlay and slates. In any case there **should be no ventilation provided between the underlay and the isolation**, because air circulation causes heat loss and condensation.

##### 4.1.5.2 Air tightness, vapour tightness and internal pressure

Condensation occurs in roofs and walls when warm humid air is cooled to or below its dew point. This can occur on surfaces or within a structure or system, e.g. within the thermal insulation, known as interstitial condensation. The air and vapour tightness of the interior of the structure plays an important part in preventing interstitial condensation.  
 Whether an airtight layer is sufficient or a vapour control layer must be placed depends on whether the construction is a cold roof (large ventilated space between insulation and underlay) or a warm roof (limited space between insulation and underlay, often not adequately ventilated). It also depends on the moisture content of the air in the building. Each situation has to be assessed individually.

**Vapour tightness:**

The **vapour screen** requires perfect placement.

**To prevent condensation inside the roof structure**, prevent vapour from migrating from the outside to the inside by placing a vapour screen **on the warm side of the insulation**, so the inside of the structure. If the vapour screen is placed elsewhere, the risk at condensation is rather increased than diminished.

Certain insulation materials have high vapour tightness. Nonetheless, because of the presence of joints and drill holes – which in practice can never be sealed perfectly – a vapour screen is placed, regardless of the typed of insulation.

**Air tightness:**

The insulated roof section must be airtight. This air tightness means the prevention of airflow through the roof construction, both from outside to inside as from inside to outside. Every imprecision can in time lead to condensation.

Air tightness can be obtained by placing an airtight screen at the inside of the roof. This may consist of e.g. a PE-foil (air tight, as well as vapour tight, when placed perfectly sealed).

**Internal pressure:**

Roofs, particularly of buildings under construction, can be susceptible to damage arising from wind induced pressure. A substantially impermeable ceiling of adequate resistance to internal pressure helps to reduce the internal wind-induced pressure transmitted to the roofing underlay and roof covering. Normal ceiling constructions in houses, when executed airtight and having sufficient dead weight, or mechanical fastening resisting the pressure involved, offer adequate protection.

**4.1.6 VENTILATION**

In the old days the attic was seen as an uninhabitable place of the house. The structure then only existed of slates on battens, fixed to the rafters of the roof structure. There was no roof insulation whatsoever.

Because of the open structure, there was plenty of ventilation, which assured that the roof structure would dry quickly.

Inhabiting attic rooms and today’s insulation requirements demand an insulated roof. But an insulated roof is a roof with quite a few risks:

- if the roof is not ventilated, any water seeping in may cause damage or rotting;
- condensation inside the roof structure, with diminishing of the insulation value or even mould development as a result;
- a damp roof structure is not immediately visible but has serious consequences;
- ...

**4.1.6.1 Use of ventilation**

- Ventilation makes the roof structure dry out more quickly. If it is not provided, the slates will remain wet longer. Dust easily attaches to a wet surface. This is an ideal ground for moss and algae. This means: **ventilation indirectly stops the slates from becoming green.**
- Ventilation avoids that the space between the roofing underlay and the slate is damp – which also means it is better for the counter-battens and the slate battens. **Ventilation prolongs the life span of the entire roof.**
- **Vapour that migrates through the roof structure from the inside must be carried off via ventilation.** Even when there is a vapour screen ventilation provided: a vapour screen never is 100% impermeable. There are always air leaks at the wall connections, the connections of the strips, drill holes of the connections, accidental tears, ... When a roof is not fully air tight the amount of condensation can amass to 120g/day. This has to be vented one way or another through ventilation.

**4.1.6.2 Realisation**

Ventilation is generated through sufficient air ventilation. This can be realised by leaving a free air gap of ideally 50 mm but with a **minimum of 25 mm**, placing an **air inlet** at the bottom of the roof **and an air exhaust** at the ridge, as well as roof ventilation (See BS 5250).

To determine the amount of ventilation needed the following sections must be used:

Ventilation Gaps	Eaves / Lower-level ventilation	Ridge / High-level ventilation
Roof pitches ≥ 15°	Minimum 100 cm <sup>2</sup> per metre run (= continuous, unobstructed gap 10 mm wide)	Minimum 50 cm <sup>2</sup> per metre run (= continuous, unobstructed gap 5 mm wide)
Roof pitches < 15°	Minimum 250 cm <sup>2</sup> per metre run (= continuous, unobstructed gap 25 mm wide)	Minimum 50 cm <sup>2</sup> per metre run (= continuous, unobstructed gap 5 mm wide)

All air voids in the roof structure should have a free air gap of ideally 50 mm (minimum 25 mm at the wall plate).

#### 4.1.6.3 Ventilation of gutter, ridge and ventilation slates

- Ventilation of the gutter: the space between the counterbattens is left open to make air inlet possible. Sufficient air inlet needs to be assured. If you should want to close up the opening at the gutter you can apply a comb filler or other ventilation profiles.
- Ventilation of the ridges: to create an air exhaust at the ridge use a ventilation under-ridge. (See § 1.3.3.2).  
If unlike in the two previous methods, there is no ventilation at the ridge and the gutter, ventilation slates are placed in the second row down from the ridge and/or up from the gutter.  
When ventilation slates are used at the ridge and the gutter, they should be set a saw to get a decent air circulation.

The ventilation slates for sale at SVK and the ventilation sections can be found in:

##### 1.3.2.11 Fibre-cement ventilation slate

A combination of ventilation slates and an air inlet or exhaust is possible as well.

## 4.2 SLATE FIXING METHOD

Before starting work, the area to be slated should be checked, to ensure that all preparatory work has been executed to standard and nothing will hamper the quality of the roofing work.

The roof is to be set out carefully, to ensure that a minimum cutting of slates is necessary. Especially try to avoid using small parts of slates. No slate less than half the width of a full slate should be used under any circumstances as this would compromise the side lap.

Load-out SVK slates on the roof safely to avoid slippage and distribute them evenly to prevent overloading of the roof structure.

**Important: Only slates with the same production date should be placed on the same roof/facade surface. Slates with different production dates should not be installed on the same roof/facade surfaces.**

1. Set out both under-eaves battens as shown in figure A. Their gauge is determined by the under-eaves slate length following the correct laps, as given in the table below.
2. The first under-eaves course is cut and head-nailed to the eaves batten (see figure B). The length of the first under-eaves course is equal to the gauge. The length of the second under-eaves course is equal to the gauge plus the head-lap. This first under-eaves course supports the disc rivets and stiffens the eaves.

The sum of the lengths of both under-eaves courses is equivalent to the full slate length, so both can be obtained by cutting a full-length slate into two unequal lengths.

The tails of both under-eaves courses and the first full slate should be aligned.

When using hook fixing, the slates are fixed with either copper nails and rivets for three-layer eaves courses or nails and hooks for two-layer eaves courses.

Length of under-eaves fibre-cement slate courses (dimensions in cm):

Slate Size	Lap	1 <sup>st</sup> under-eaves slate length [A]	2 <sup>nd</sup> under-eaves slate length [B]
60 x 30	11	24.5	35.5
60 x 30	10	25.0	35.0

3. The slates for the second under-eaves course are centre-nailed through site-drilled holes to the eaves batten. Use a SVK slate-and-a-half width at the verge, to obtain a broken bond over the first course. Prior to fixing, drill an extra hole half a slate width in from the verge and 30 mm up, to allow for the copper disc rivet that will fix the first full slate, see figure C.
4. Fix the first course of full size SVK slates by centre-nailing them. At the verge, an additional hole is drilled 50 mm from the outside edge of the slate, and 30 mm plus gauge from the bottom edge, see figure D. This hole is required for the extra copper disc rivet in the next course.
5. Each slate of the first full size row is now fixed with
  - Two nails, firmly driven into the batten. The hole in the slates is larger than the nail diameter to allow working.
  - The slates must always be centre-nailed;
  - A disc rivet placed between the edges of the two lower slates. The stem of the disc rivet projects through the hole in the tail of the appropriate slate in the next course and is bent down the roof slope to secure the tail of the slate, not too tight however, to allow the working of the slates.
6. At the verge, every second course a slate-and-a-half width slate is used. Drill 3 nail holes in the slate on the batten line for nailing, and two additional holes for the copper disc rivets, see figure E.
7. Proceed (see figure F) as described above to cover the whole roof area.

For the remaining courses, a third copper disc rivet hole is required in the slate-and-a-half slates, to accommodate the disc rivet for the next single width verge slate. Drill this hole half the single slate width from the side and 30 mm + gauge from the bottom edge (or tail).

8. Trim to verges, hips, valley and ridges as necessary.

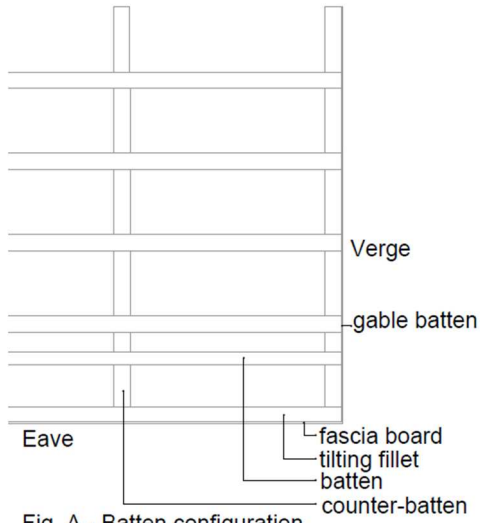

Fig. A - Batten configuration

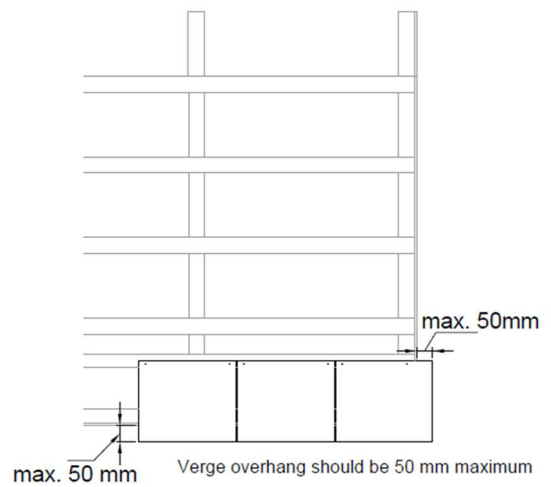
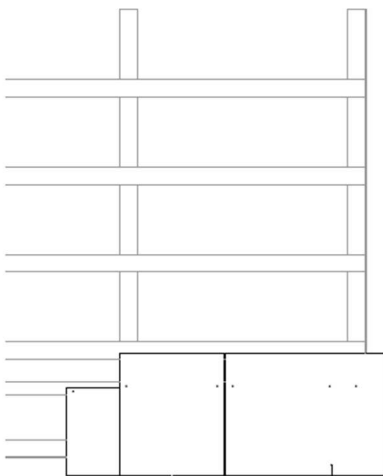
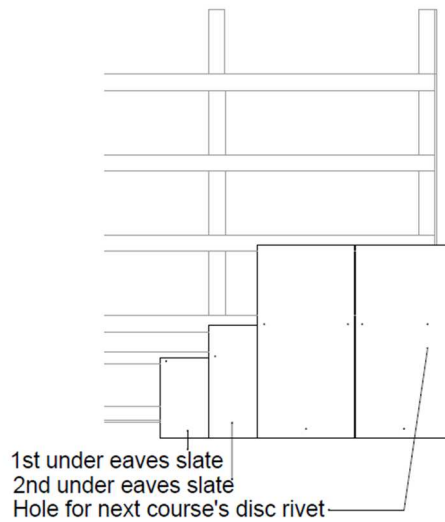

Fig. B - Eaves: 1st under eaves course



Holes for next course's disc rivet

Fig. C - Eaves: 2nd under eaves course



1st under eaves slate  
2nd under eaves slate  
Hole for next course's disc rivet

Fig. D - Eaves: 1st course of standard slates

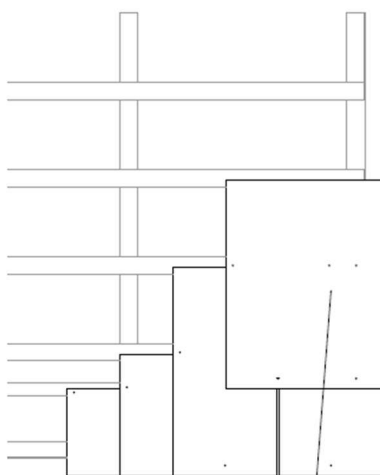

Hole for next course's disc rivet

Fig. E - Verge: using slate-and-a-half to break bond

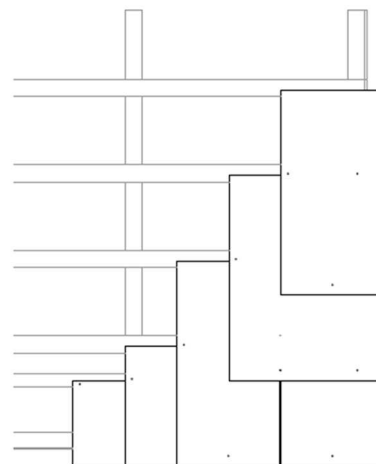

Fig. F - Proceed this way for the rest of the roof surface



### 4.3 CONSTRUCTION DETAILS

Apart from the detailing given in this chapter, other situations may require a specific execution, which is not treated here. In case of doubt, do not hesitate to ask for advice from our Technical Department.

In any case, a number of basic rules must always be respected:

- The gap created by the counter-battens must guide any water ingress to the bottom of the roof. See to it that this space is always kept free.
- Take all necessary measures to obtain a watertight roof.
- See to it that the dividing layer between the inside of the building and the roof area is airtight and, if necessary, an effective water vapour barrier is applied (even when this is not visible in the detail).
- Insulation must be applied continuously, avoiding thermal bridges (to keep the details clear insulation may in some places be omitted from the drawings).

Wherever possible, we advise to use proprietary dry roofing products and systems to guarantee watertightness of the different roof details. Only where these are unavailable do we advise to use other materials (e.g. zinc, lead, etc.).

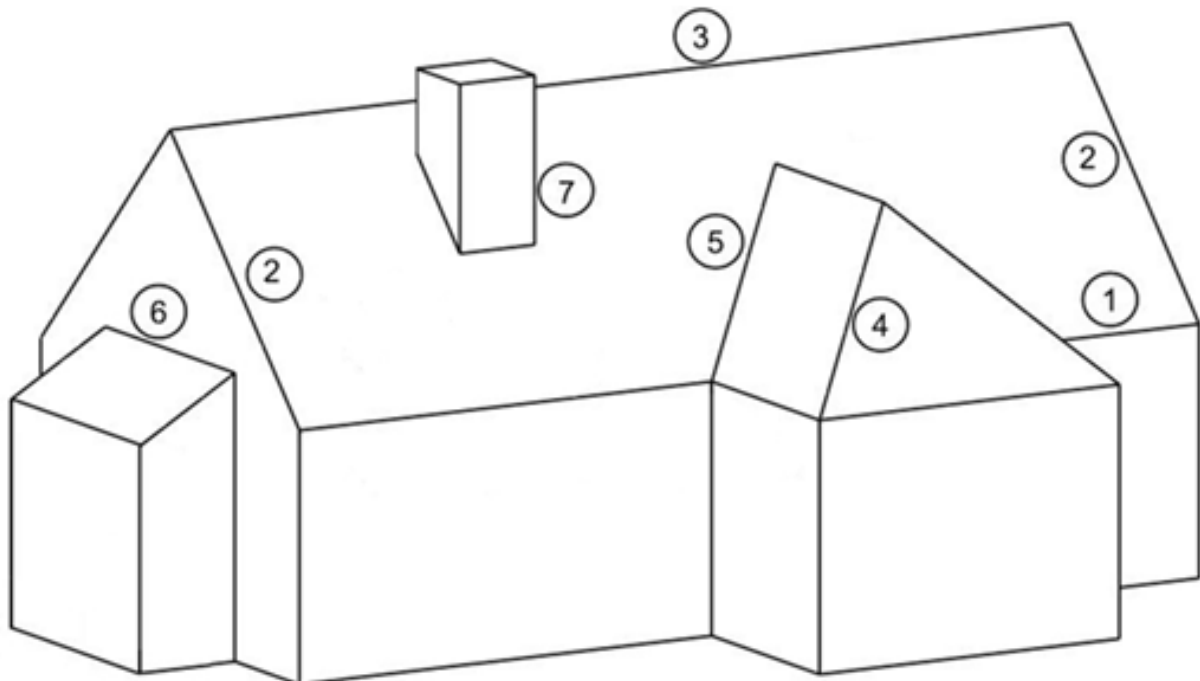

1. eaves (see § 4.3.1)
2. verges (see § 4.3.2)
3. ridges (see § 4.3.3)
4. hips (see § 4.3.4)
5. valleys (see § 4.3.5)
6. abutments (see § 4.3.6)
7. chimneys (see § 4.3.6.4)

Except when otherwise stated, all roofing details are given for a ventilated roof covering (ventilation above the underlay).

### 4.3.1 EAVES

To ensure the long term performance and functionality of the roof, three courses of fibre cement slates are laid at all eaves. The dimensions of the typical under-eaves slates can be found in the table below.

Format [mm]	Laps [mm]	1st under eaves slate Length A [mm]	2nd under eaves slate Length B [mm]
600x300	90	255	345
600x300	100	250	350
600x300	110	245	355

#### 4.3.1.1 Ventilation underneath the underlay

Set out the battens, remembering to provide the correct overhang of the eaves slates to the gutter.

Do not forget to place a tilting piece (or underlay support tray) at the eaves. The tilting piece:

- ensures that all moisture is discharged safely into the gutter;
- supports both first and second undereave courses of the slates;
- lifts the eave and undereave courses up, between 8 and 15 mm, to ensure an even inclination over the slate surfaces.

Where the eaves ventilation is located on the eaves support, allowance should be made for its height.

Chapter 4.2 explains how to place and fix the undereaves courses.

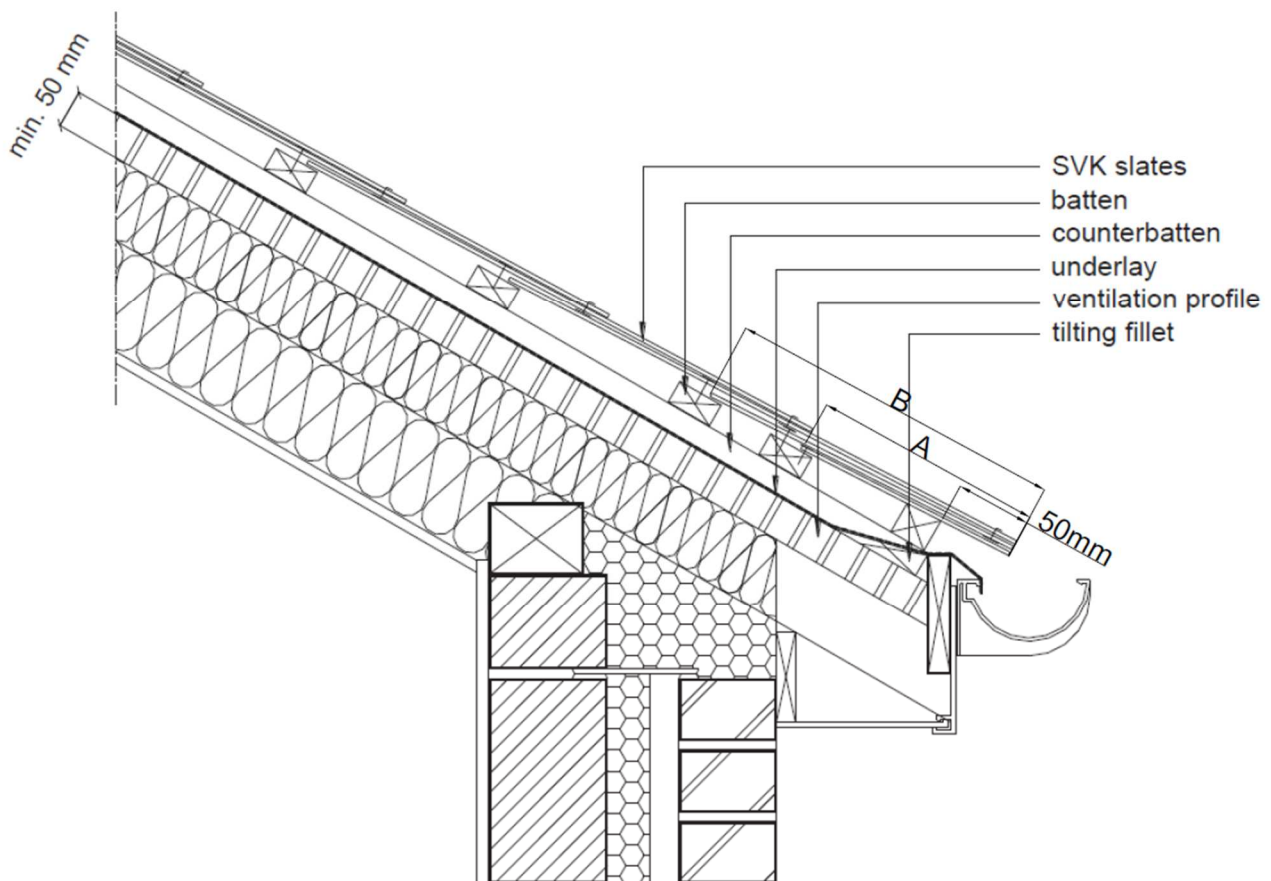

#### 4.3.1.2 Ventilation above the underlay

We strongly advise to use ventilation above the underlay. The counter-battens provide an uninterrupted gap so the evacuation of the infiltrated water into the gutter and the section ventilation inlet at the eaves are guaranteed.

The bottom batten is 4 mm thicker than the other battens, to obtain the same pitch of the slates over the whole roof surface. It is strongly advisable to put a comb filler at the eaves, this avoids blockage of the ventilation gap by dry leaves, bird nests, etc.

The recommended overhang for:

- a 100 mm wide gutter is 45 to 55 mm, measured horizontally from the fascia, tilting fillet or wall face.
- gutters of different widths should be taken to the center-line of the gutter or 45 to 55 mm, whichever is the lesser.

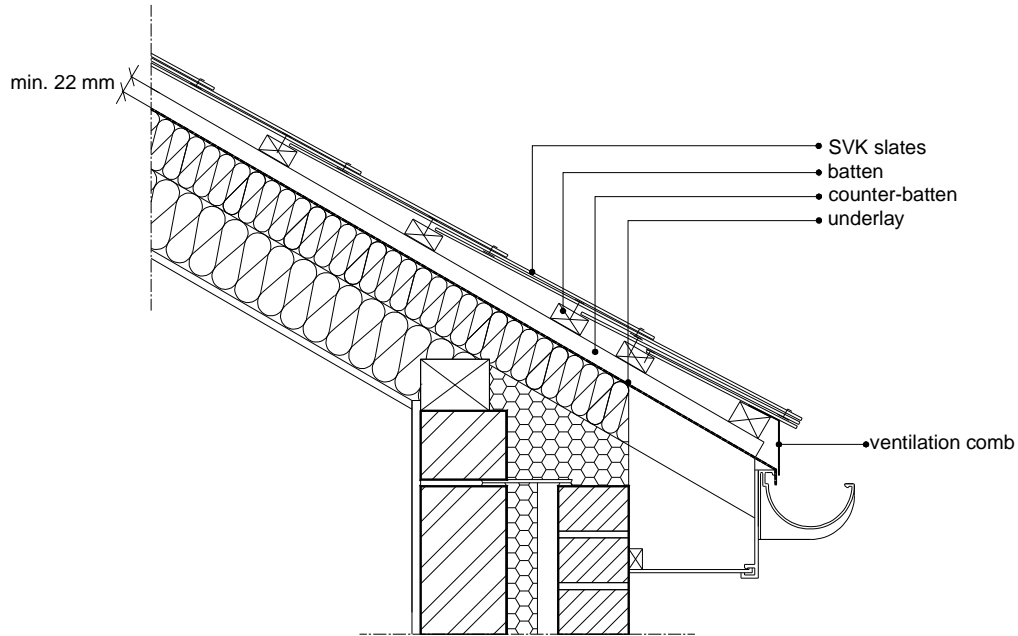

### 4.3.2 VERGES

Verges may be straight or raked. They are exposed to high and turbulent wind loads, being situated at the edge of a roof surface. Therefore they must be adequately secured against lifting. See § 4.2 for laying and fixing the slates at the verge.

The plain overhanging verge used to be a common way of forming verges: slates overhang the gable batten.

Battens should overlap onto the outer skin of the brickwork or the undercloak material by minimum 50 mm or, in the case of an overhanging verge, onto the flying rafter/ladder truss.

Where the distance of the nearest batten fixing to the rafter is greater than 300 mm, an additional fixing should be used.

We strongly advise however to use verge slates or other finishing systems.

When hook fixing the slates, a slate and a slate-and-a-half should be used in alternate courses. Each verge slate should be hooked and fixed with two centre-nails and one head-nail. In areas of high wind exposure a clip or verge closure can be used to increase wind resistance.

Bedded verges are not recommended by SVK. If however SVK double-lap fibre-cement slates are used on bedded verges we refer to the BS 5534 for regulations and the BS 8000-6 for working instructions.

#### 4.3.2.1 Verges finished with verge slates

The verge slates are laid on top of the slates. They are fixed on their vertical side by 2 nails, diameter 2.65 mm, in the head-lap area of the slates. Predrill the holes with a diameter of 4 mm, to allow the working of the verge slates. Except for roofs in very sheltered areas, it is also necessary to fix the upper surface of the verge slates. Predrill two 4 mm diameter holes in the slate underneath and fix with a ridge hook. When using hook fixing for the slates, each verge slate should be hooked and nailed. In case of high wind exposure, use an extra clip to increase wind resistance.

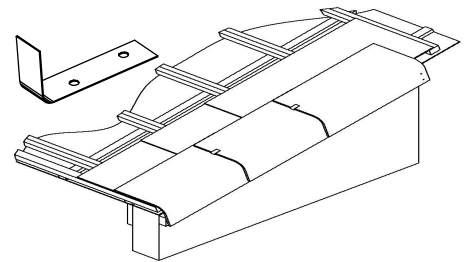

#### 4.3.2.2 Verge finishing with facade slates

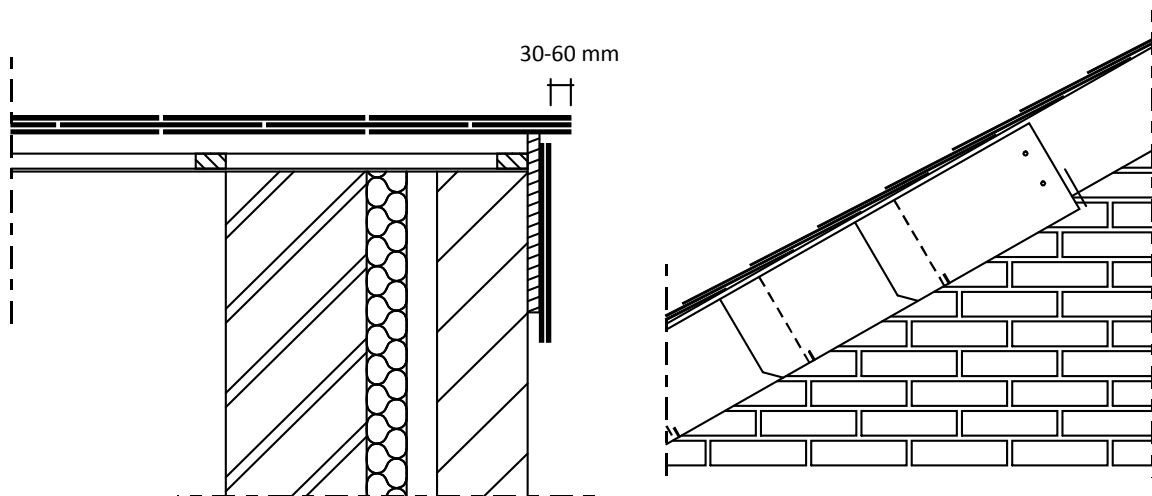

At the verge of the roof surface only full or one-and-a-half slates may be placed. The outer top corners of the outer slates at the edge of the roof surface need to be cut sloping (preferably at a 45° angle) to prevent water from seeping in through the upper edge. We also advise to cut the bottom corners sloping, so the water runs towards the roof surface, away from the facade.

At the facade level the slates are attached to a gable plank with two slate nails and a hook. They overhand the gable plank so a dripping edge is created.

#### 4.3.2.3 Verges finished with dry-fix verge trims

Dry-fix verge trims are an alternative to verge slates. Lay dry verge systems in accordance with their manufacturers' instructions. See to it that the verge strip leads the water away from the facade surface. Ensure that the verge slates are extended fully into the verge strip and that the latter firmly holds them.

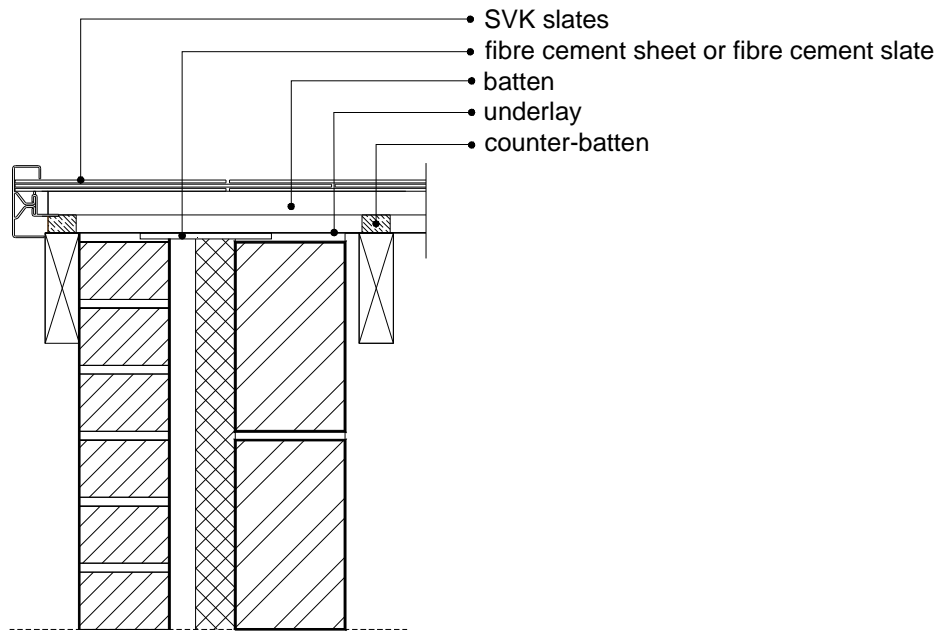

### 4.3.3 RIDGES

For roofs laid with double-lap SVK fibre-cement slates, there are many possibilities for dry ridge finishing.

Ridges of fibre-cement in different angles are readily available. It is recommended that the top two courses are set out with shortened slates to ensure that the minimum head-lap of the ridge over the penultimate course is achieved. When hook fixing is used, use two nails and one hook to fix the slates at the ridge.

#### **Half round ridge:**

Position and fix the top slating battens or additional battens to suit the fixing of the SVK ridge cappings. Use a raised ridge board of at least 25 mm thick.

Lay the ridge pieces with the internal socket joints facing towards, or the external socket joints facing away from, the prevailing wind. Fix the ridge cappings into the ridge board to a true line with a ridge clip and two nails. Drill in the middle of the ridge and screw a self-sealing 60mm x 6.3mm wood screw. The pre-drilled hole should be wide enough to allow movement of the ridge but not too wide so that the watertightness is still guaranteed. To make ventilation possible, a supple ventilation under ridge (see § 1.3.3.2) should be placed.

#### **Type A or Type B ridge:**

Position and fix the top slating battens or additional battens to suit the fixing of the SVK ridge cappings. Use a raised ridge board of at least 25 mm thick. An additional ridge fix batten downslope is required for the Fixing of a self-sealing wood screw, minimal dimension 60mm x 6.3mm.

Lay the ridge pieces with the internal socket joints facing towards, or the external socket joints facing away from, the prevailing wind. Fix the ridge cappings into the ridge board to a true line with a ridge clip and two nails. Drill the ridges as required, the screws penetrate the ridge in the middle on both sides, 50mm from the bottom edge. The pre-drilled hole should be wide enough to allow movement of the ridge but not too wide so that the watertightness is still guaranteed. To make ventilation possible, a supple ventilation under ridge (see § 1.3.3.2) should be placed.

The ridges are placed against the predominant wind direction with a minimal head-lap of 70 mm, starting with a start end ridge and ending with a stop end ridge. End ridges should always be full length. Shorten the last ridge before the stop end ridge if necessary.

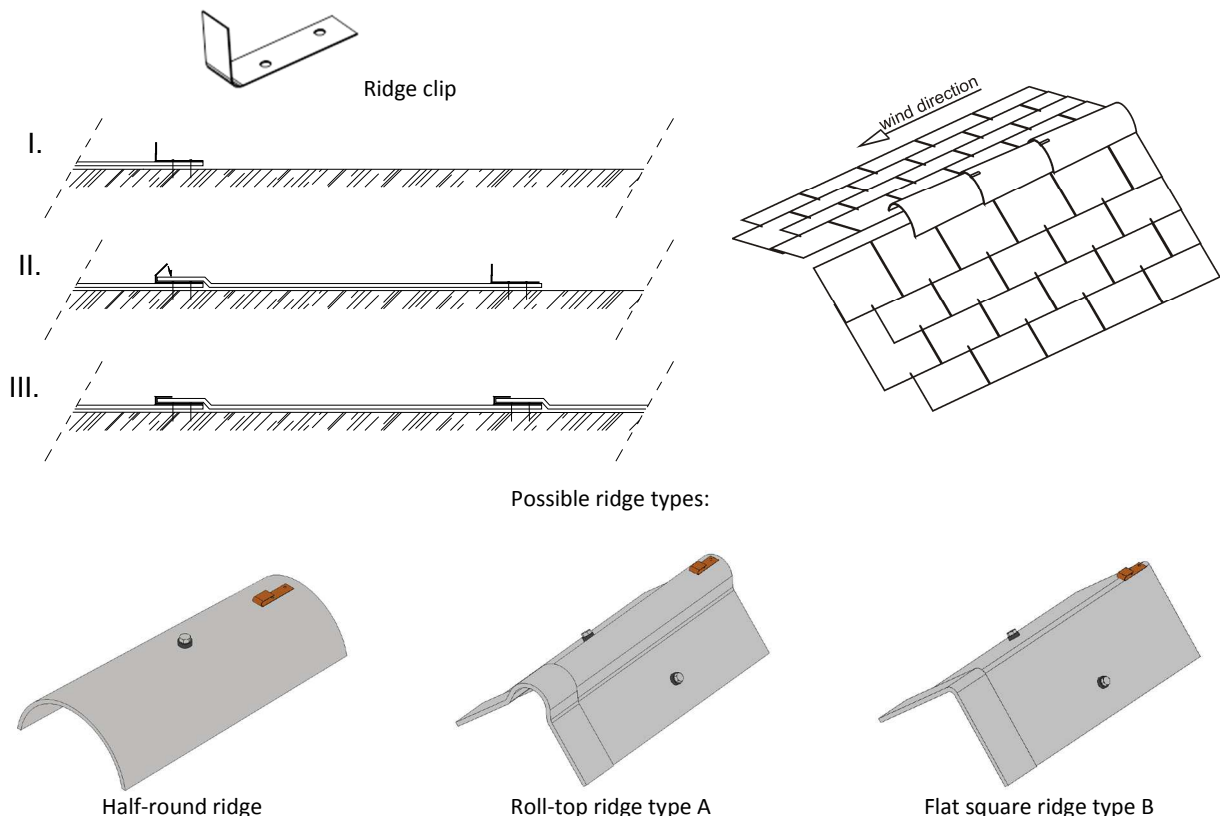

In case dry ridges are used in another material (concrete, clay, sheet metal ridges), they should be laid in accordance with the slate and/or the sheet metal manufacturer's technical recommendations.

Mortar bedding of ridge tiles onto fibre-cement slates is not recommended by BS 5534. If however SVK double-lap fibre-cement slates are used with bedded ridges we refer to the BS 8000-6 for working instructions. Special attention has to be paid to the underlay at the ridge.

#### 4.3.3.1 Non ventilated ridge finishing

Slates are laid up to the ridge, leaving just a small gap between the slated surfaces and the ridge. In this case ventilation slates are placed in the second row down from the ridge, to ensure a continuous airflow. Possible ridge types: half-round ridge, roll-top ridge type A, flat square ridge type B.

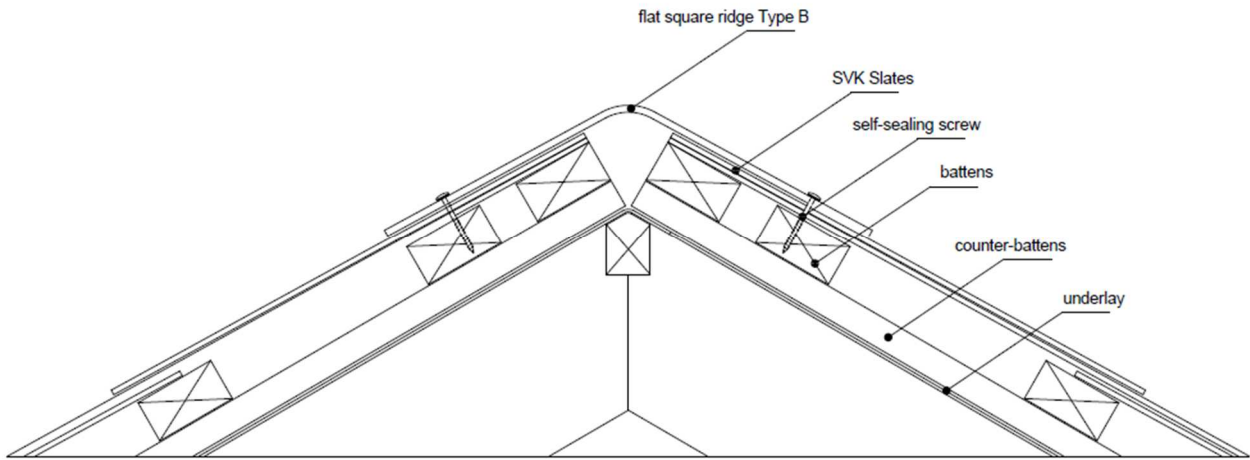

#### 4.3.3.2 Ventilated ridge finishing

For roofs finished with fibre-cement ridges, use a ventilation under-ridge (see § 1.3.3.2) to provide the necessary ridge ventilation. Leave sufficient space between the slated surfaces and the ridge to allow for ventilation. Possible ridge types: half-round ridge, roll-top ridge type A, flat square ridge type B.

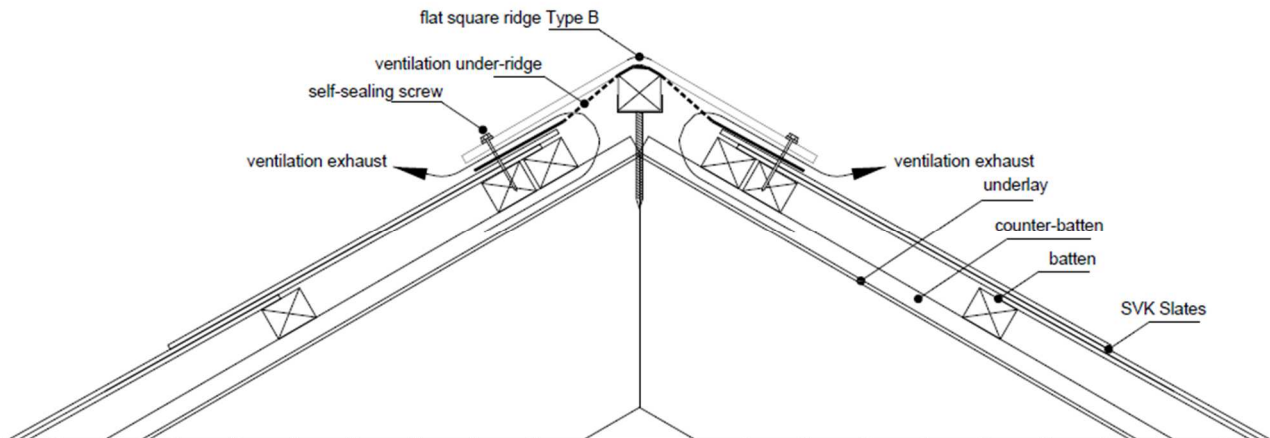

#### 4.3.4 HIPS

The conversion table below indicates the required angle of the ridges used as capping, for a specific roof pitch.

Ridge application for roof pitch of:	Ridge angle	Conversion to roof pitch when used as hip ridge on 2 identical roof pitches of:
25°	130°	37°
30°	120°	45°
40°	100°	65°

##### 4.3.4.1 Mitred hips

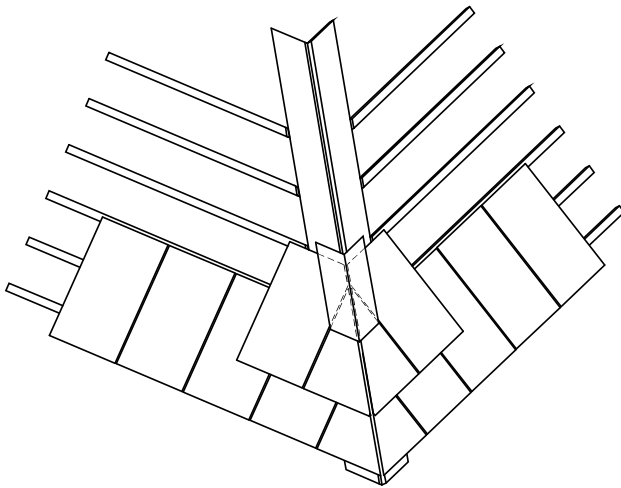

A minimum roof pitch of 30° is recommended for mitred hips. Cut slates to a close mitre to the hip line. Use wide slates (cut from doubles) rather than using small pieces of slate, for all but the steepest pitches. This ensures that the raking cut provides enough width at the head of the slates to resist wind uplift. Lay cut soakers with each course. They should extend a minimum of 100 mm on each side of the hip line for pitches of 35° and above, and a minimum of 150 mm for pitches between 30° and 35°. The soakers should have a minimum length of the sum of the batten gauge + the head-lap + 25 mm. They are fixed into the support with two slate nails.

The slates themselves are fixed with at least two nails and a disc rivet.

In locations with severe exposure external tail fittings such as screws, washers and caps might be necessary to resist high wind loads, except in sheltered locations.

When hook fixing is used, external tail fittings such as screws, washers and caps might be necessary to resist high wind loads.

##### 4.3.4.2 Hips finished with SVK fibre-cement cappings

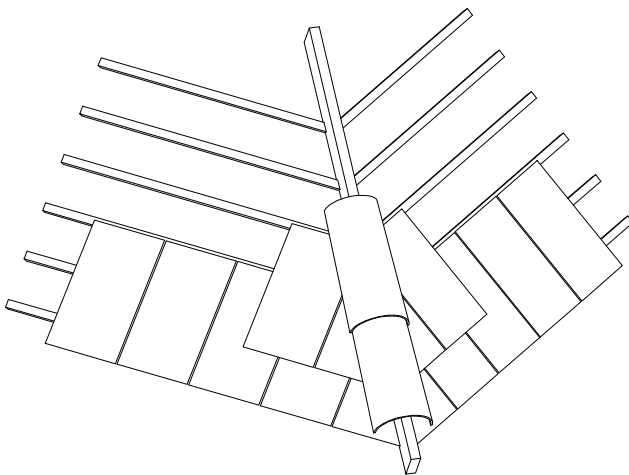

The hips are basically finished the same way as ridges (see § 4.3.3).

Position and fix a raking batten to either side of the hip rafter to suit the fixings of the hip cappings. Rake cut slates to the hip line. Wherever this is necessary, make extra holes for fixing the slates. Cut the slates close to the hip line, the head-lap of the slates by the hip capping must be minimum the head-lap. The slates are fixed alongside the hip line supplementary with 2 nails.

When using hook fixing at hips, the slates should be hooked and nailed. The hip must be capped.

The ridges are placed with a downward socket. Cut the bottom hip cappings from a full-length unit to align with the eaves.



#### 4.3.4.3 Hip finishing with a German corner (type bardeli)

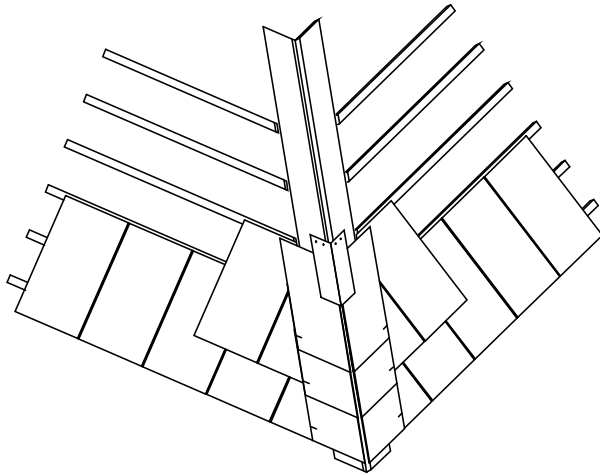

This type of construction can be applied for roof surfaces with an equal or different inclination.

The German corner is formed by an extra row of slates on both sides of the hip that cover the slates of the roof surface. The placement is comparable with the ridge finishing with slates. They are attached at the head-lap with minimum 2 nails and 1 slating hook to bevelled slates of about 100 mm wide, against which the slates are joined. The hip slates cover each other half a slate and cover at least 70 mm of the slates in the roof surface. In-between the hip slates lead soakers are placed with a width of minimum 140 mm and a length equal to the visible part (= half a slate) increased with 50 mm for the Fixing to the roof construction with 2 nails per roof surface. They are covered together with the slates so they are held back 20 mm compared to the covering slates and they overlap each other 50 mm.

#### 4.3.4.4 Other hip cappings

In case dry hip cappings in another material are used (concrete, clay, sheet metal ridges), they should be laid in accordance with the slate and/or the sheet metal manufacturer's technical recommendations.

**Bedded hip cappings are not recommended by BS 5534.** If however SVK double-lap fibre-cement slates are used with bedded cappings, we refer to the BS 8000-6 for working instructions.

## 4.3.5 VALLEYS

### 4.3.5.1 Mitred valleys

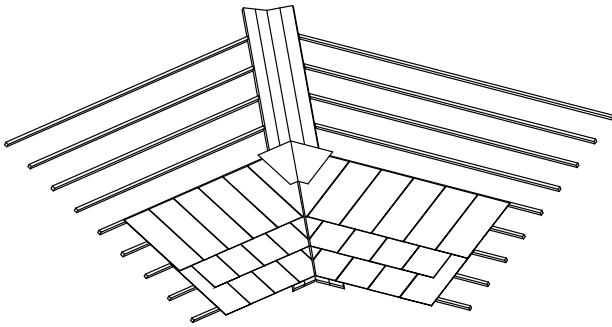

Cut the slates to a close mitre to the valley line. Make sure the tail of the slates is always wide enough. Use wide slates (cut from doubles) rather than using small pieces of slate.

Lay cut soakers with each course. These soakers extend minimum half the width of a standard slate on each side of the valley line. Butterfly wing shaped soakers have a minimum length of the sum of the extended head-lap (measured along the valley line) + extended gauge at the valley + 25 mm. They are fixed into the support with two slate nails per roof pitch.

The slates themselves are fixed with at least two nails and a disc rivet or another appropriate tail fixing. Wherever this is necessary, make extra holes for fixing the slates.

Mitred valleys are not recommended in locations with severe exposure, nor if the roof pitch is less than 35° or the valley length is greater than 6 m.

Avoid mitred valleys at pitches below 50°, if the roof pitches intersect at an angle more acute than 90° on plan or have different roof pitches.

### 4.3.5.2 Open valleys

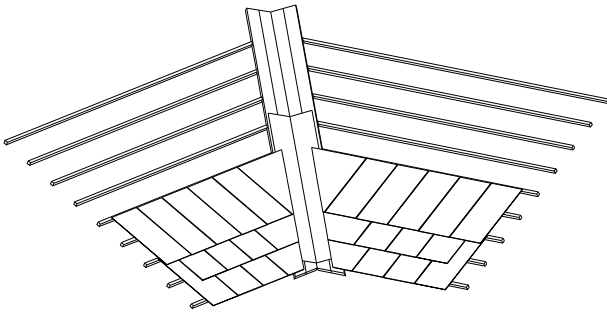

On both sides of the valley line a timber lay-board is applied. On top of these a sheet metal valley is laid, fully supported on lay-boards with a thickness of minimum 19 mm.

The slates are cut to rake, parallel to the valley centre. Use wide slates (cut from doubles) rather than using small pieces of slate, ensuring that the tail of the slates is wide enough. In the centre is an open channel, with slates overhanging the tilting fillet by minimum 50 mm.

The width of the valley gutter depends on the design rainfall rate, the roof pitch and the plan area of the roof. The width of the gutter can range from minimum 100 mm to maximum 250 mm (see BS 5534). The lead to line valley gutters must be at least 500 mm wide (maximum 650 mm).

The slates themselves are fixed with at least two nails and a disc rivet or another appropriate tail fixing. Wherever this is necessary, make extra holes for fixing the slates.

#### 4.3.6 ABUTMENTS

##### 4.3.6.1 Top abutments

The length of the top two courses of slates should ensure the minimum lap is maintained in combination with an apron and cover flashing.

If ventilation has to be provided, it has to be realised with ventilation slates.

In the wall above, an effective flashing must be provided, to avoid water ingress to the inside of the construction.

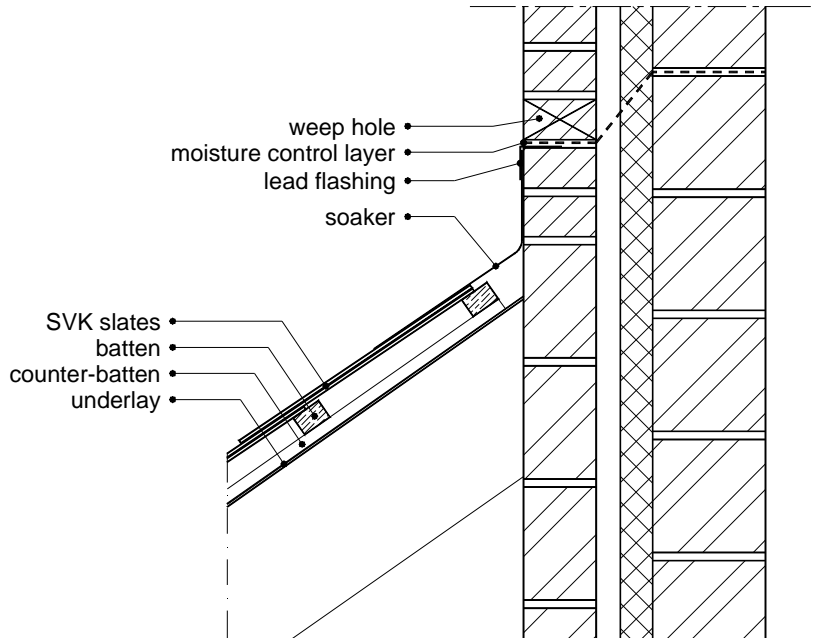

##### 4.3.6.2 Side abutments

Slating should be finished close to the abutment. A cover flashing should be used in combination with soakers. Use soakers on each course with a length  $\geq$  the length of the slate gauge + the head-lap + 25 mm.

The top of the flashing should be turned down over the head of the batten and secured. The horizontal side of the flashing should be covered by the slate, at least half a slate width, the vertical side of the flashing reaches at least 75 mm above the slate surface.

Where used, proprietary abutments or secret gutters are detailed according to the manufacturer's recommendations and should be adequately sized for the length of the abutment with sufficient provision for water outlet. Where there is a risk of blockage by debris, a combination of a cover flashing and abutment gutter could be necessary.

Battens should be located between 10 mm and 25 mm from the face of the abutment.

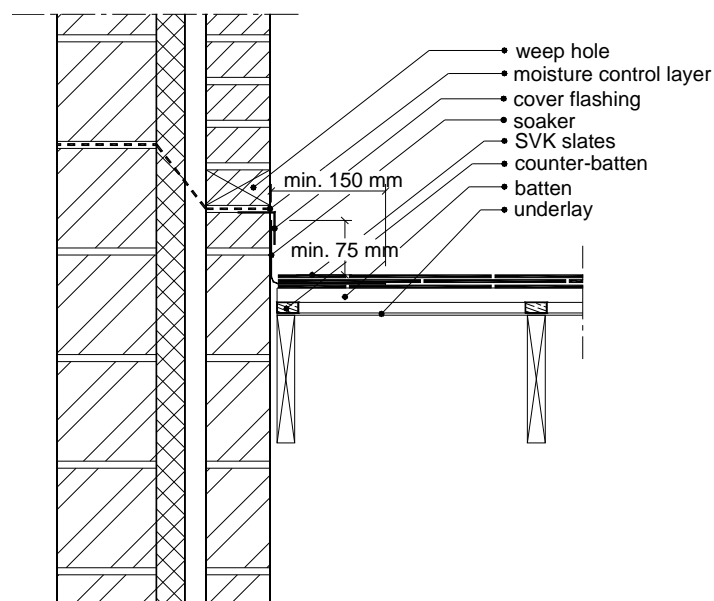

#### 4.3.6.3 Back abutments

For SVK fibre-cement slates intended for the use at a back abutment, the following should be considered:

- The bottom course should overhang into the back gutter by 45 mm to 55 mm horizontally or to the center of the gutter, whichever is the lesser.
- Ensure the bottom course is not kicked up and is in the same plane as the adjacent courses.
- A double course of slates, laid to give a broken bond, should be used at the bottom course.
- The flashings must ensure that, in case of blockage by debris, no water ingress into the building can occur.
- The underlay should extend over the soaker by 100 mm to 150 mm.

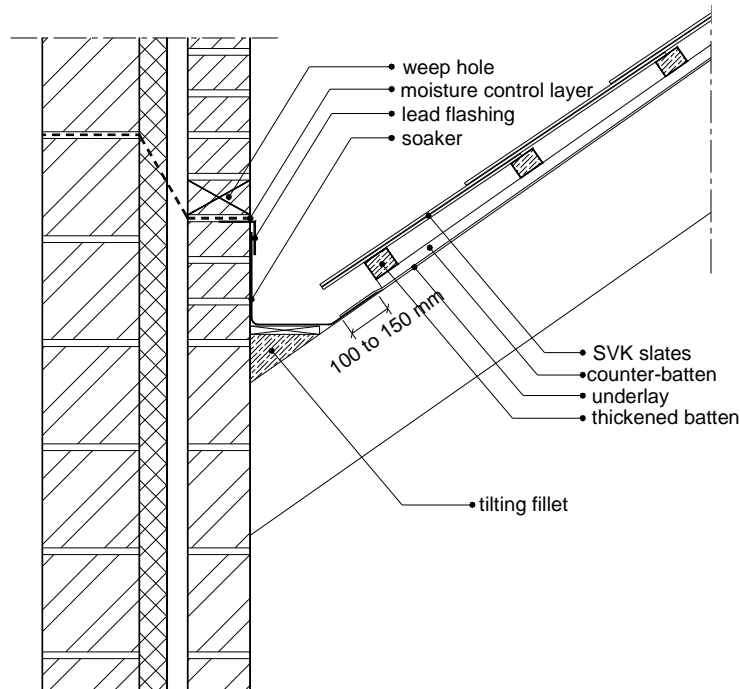

#### 4.3.6.4 Chimneys

Finish the roof at the top, the side and the bottom, as described above – as top, side and back abutment. Give special attention to the connections of the different flashings at the angles.

## 5 REFERENCES

- EN 492 - Fibre-cement slates and their fittings for roofing – Product specification and test methods.
- EN 13501-1+A1 - Fire classification of construction products and building elements - Part 1: Classification based on results of testing of the fire behavior.
- BS 5534 - Code of practice for slating and tiling (including shingles).
- BS 8000-6 - Workmanship on building sites – Part 6: Code of practice for slating and tiling of roofs and claddings.
- BS 8104:1992 Code of practice for assessing exposure of walls to wind-driven rain
- BE EN 1202-2 Specification for nails. Copper nails
- BS EN 1202-3 Specification for nails. Aluminium nails
- BS EN 10088-3 Stainless steels. Technical delivery conditions for semi-finished products, bars, rods, wire, sections and bright products of corrosion resisting steels for general purposes
- All relevant standards, regulations, guiding documents, etc. listed in the reference chapter of the above standards.